



## Industrial controller KS 40-1, KS41-1 and KS42-1



*universal line*  
*universal line*

**Operating manual**

**English**

**9499-040-62711**

Valid from: 8499





More efficiency in engineering,  
more overview in operating:  
The projecting environment for the BluePort® controllers



**ATTENTION!**  
Mini Version and Updates on  
[www.pma-online.de](http://www.pma-online.de)  
or on PMA-CD

### Description of symbols:

-  General information
-  General warning
-  Attention: ESD sensitive devices

© PMA Prozeß- und Maschinen-Automation GmbH • Printed in Germany  
All rights reserved. No part of this document may be reproduced or published in any form or by any means  
without prior written permission from the copyright owner.

A publication of PMA Prozeß- und Maschinen Automation  
P.O.Box 310229  
D-34058 Kassel  
Germany

## Contents

---

<b>1</b>	<b>Mounting</b> . . . . .	<b>5</b>
<b>2</b>	<b>Electrical connections</b> . . . . .	<b>6</b>
2.1	Connecting diagram . . . . .	6
2.2	Terminal connection . . . . .	6
<b>3</b>	<b>Operation</b> . . . . .	<b>10</b>
3.1	Front view . . . . .	10
3.2	Behaviour after power-on . . . . .	11
3.3	Operating level . . . . .	11
3.4	Maintenance manager / Error list . . . . .	12
3.5	Self-tuning . . . . .	14
3.5.1	Preparation for self-tuning . . . . .	14
3.5.2	Self-tuning sequence . . . . .	14
3.5.3	<b>Self-tuning start</b> . . . . .	<b>15</b>
3.5.4	<b>Self-tuning cancellation</b> . . . . .	<b>15</b>
3.5.5	<b>Acknowledgement procedures in case of unsuccessful self-tuning</b> .	<b>16</b>
3.5.6	<b>Examples for self-tuning attempts</b> . . . . .	<b>16</b>
3.6	Manual tuning . . . . .	17
3.7	Alarm handling . . . . .	18
3.8	Operating structure . . . . .	20
<b>4</b>	<b>Configuration level</b> . . . . .	<b>21</b>
4.1	Configuration survey . . . . .	21
4.2	Configuration . . . . .	22
4.3	Set-point processing . . . . .	29
4.4	Configuration examples . . . . .	30
4.4.1	On-Off controller / Signaller (inverse) . . . . .	30
4.4.2	2-point controller (inverse) . . . . .	31
4.4.3	3-point controller (relay & relay) . . . . .	32
4.4.4	3-point stepping controller (relay & relay) . . . . .	33
4.4.5	Continuous controller (inverse) . . . . .	34
4.4.6	$\Delta Z$ Y - Off controller / 2-point controller with pre-contact . . . . .	35
4.4.7	KS4x-1 with measured value output . . . . .	36

<b>5</b>	<b>Parameter setting level.</b>	<b>37</b>
5.1	Parameter survey	37
5.2		37
5.3		37
5.4	Parameters	38
5.5	Input scaling	40
5.5.1	Input 1 nP.1	40
5.5.2	Input 1 nP.2	40
<b>6</b>	<b>Calibration level</b>	<b>41</b>
<b>7</b>	<b>Programmer</b>	<b>44</b>
<b>8</b>	<b>Timer</b>	<b>46</b>
8.1	Setting up the timer	46
8.1.1	<b>Operating modes</b>	<b>46</b>
8.1.2	<b>Tolerance band</b>	<b>47</b>
8.1.3	Timer start	47
8.1.4	Signal end	48
8.2	Determining the timer run-time	48
8.3	Starting the timer	48
<b>9</b>	<b>BlueControl.</b>	<b>49</b>
<b>10</b>	<b>Versions.</b>	<b>50</b>
<b>11</b>	<b>Technical data.</b>	<b>51</b>
<b>12</b>	<b>Safety hints</b>	<b>55</b>
12.1	Resetting to factory setting	56

**1** Mounting

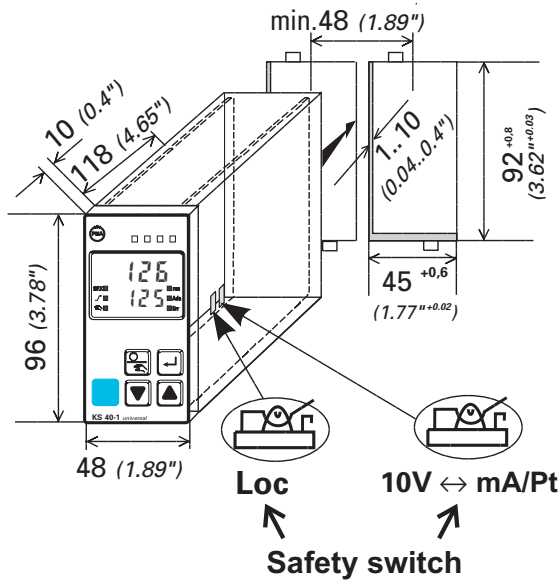

max. 60°C  
 min. 0°C

max. 95% rel. %

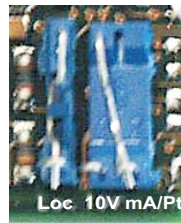

Front view KS41-1

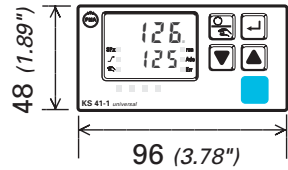

Front view KS42-1

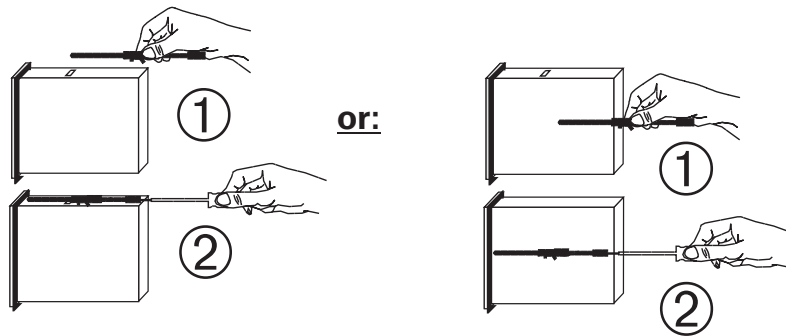
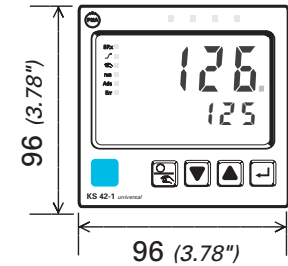

**Safety switch:**

For access to the safety switches, the controller must be withdrawn from the housing. Squeeze the top and bottom of the front bezel between thumb and forefinger and pull the controller firmly from the housing..

10V ↔ mA/Pt	right ❶	Current signal / Pt100 / thermocouple at <i>1 nP. 1</i>
	left	Voltage signal at <i>1 nP. 1</i>
Loc	open	Access to the levels is as adjusted by means of BlueControl (engineering tool) ❷
	closed ❶	all levels accessible without restriction

❶ Factory setting

❷ Default setting: display of all levels suppressed, password *PASS = OFF*



**Safety switch 10V ↔ mA/Pt always in position left or right. Leaving the safety switch open may lead to faulty functions!**



**Caution!** The unit contains ESD-sensitive components.

**2** Electrical connections

**2.1** Connecting diagram

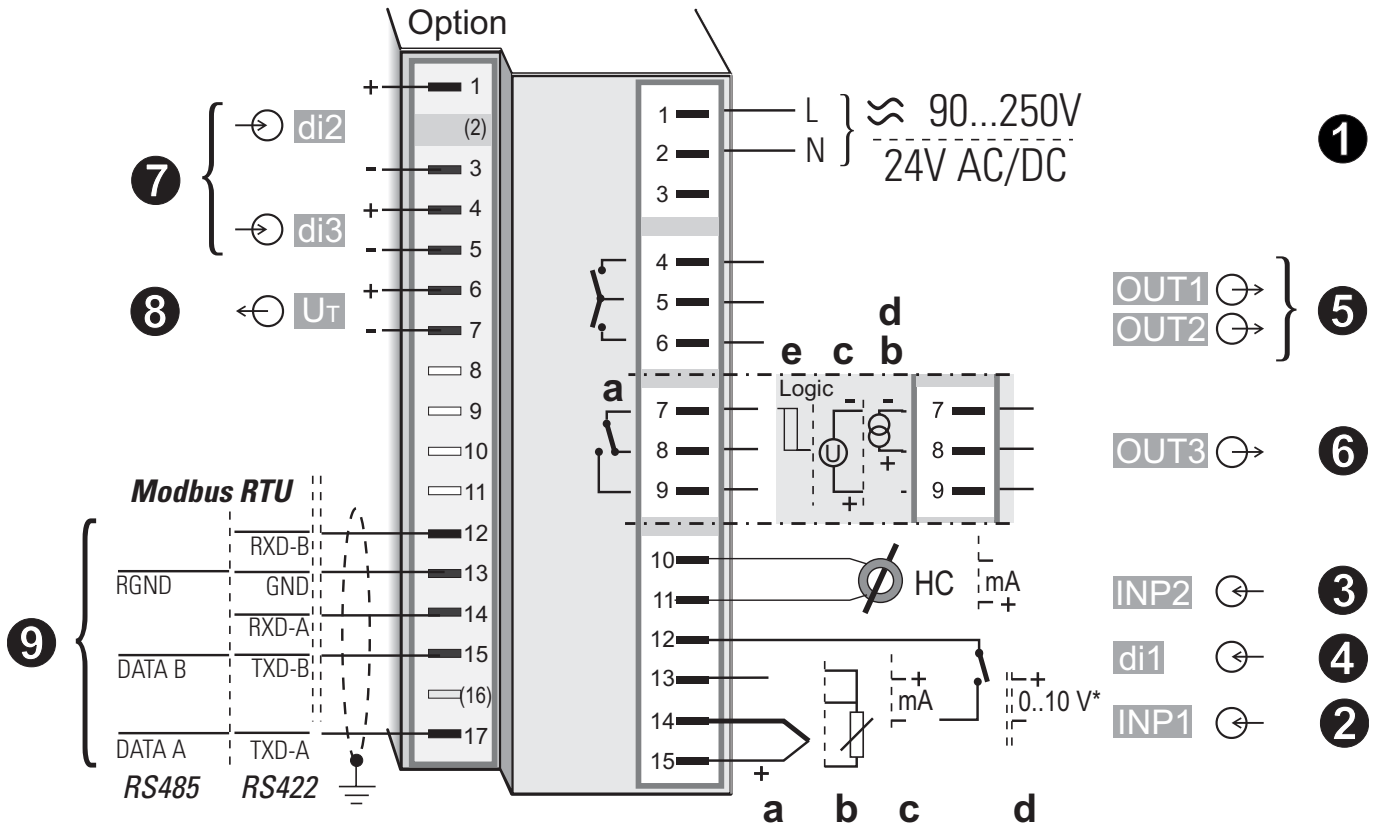

\* Safety switch mA ↔ V in position left

- i** Dependent of order, the controller is fitted with :
  - flat-pin terminals 1 x 6,3mm or 2 x 2,8mm to DIN 46 244 or screw terminals for 0,5 to 2,5mm<sup>2</sup>

**2.2** Terminal connection

**Power supply connection 1**

See chapter 11 "Technical data"

**Connection of input INP1 2**

Input for variable x1 (process value)

- a** thermocouple
- b** resistance thermometer (Pt100/ Pt1000/ KTY/ ...)
- c** current (0/4...20mA)
- d** voltage (0/2...10V)

**Connection of input INP2 ③**

Heating current input (0...50mA AC) or input for ext. set-point (0/4...20mA)

**Connection of input di1 ④**

Digital input, configurable as switch or push-button

**Connection of outputs OUT1/2 ⑤**

Relay outputs 250V/2A normally open with common contact connection

**Connection of output OUT3 ⑥**

- a relay (250V/2A), potential-free changeover contact universal output
- b current (0/4...20mA)
- c voltage (0/2...10V)
- d transmitter supply
- e logic (0..20mA / 0..12V)

**Connection of inputs di2/3 ⑦ (option)**

Digital inputs (24VDC external), galvanically isolated, configurable as switch or push-button

**Connection of output  $U_T$  ⑧ (option)**

Supply voltage connection for external energization

**Connection of bus interface ⑨ (option)**

RS422/485 interface with Modbus RTU protocol

**③ INP2 current transformer**

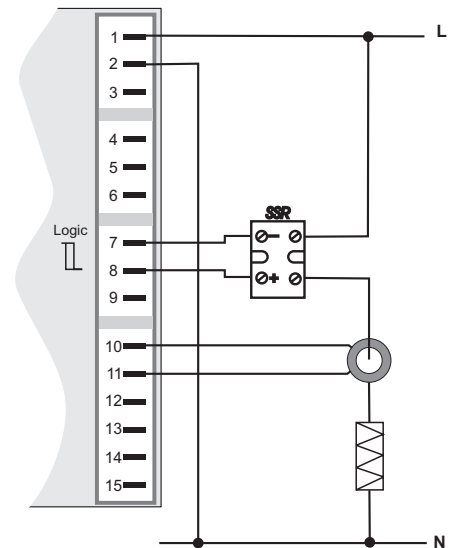

**⑤ OUT1/2 heating/cooling**

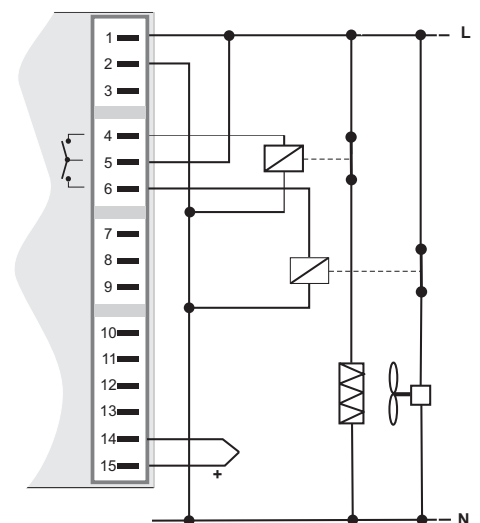

## 7 8 di2/3, $U_T$ 2-wire transmitter supply

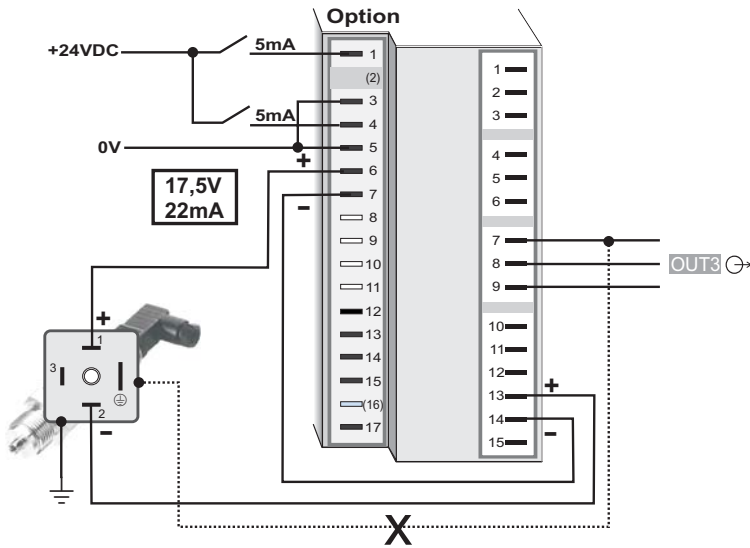

## 6 OUT3 transmitter supply

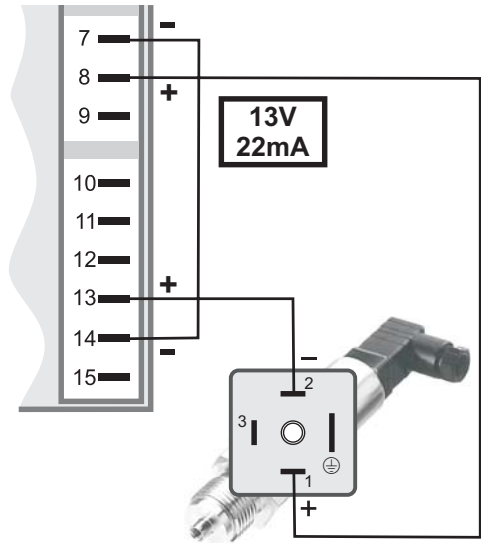

If  $U_T$  and the universal output OUT3 is used there may be no external galvanic connection between measuring and output circuits!

## 6 OUT3 as logic output with solid-state relay (series and parallel connection)

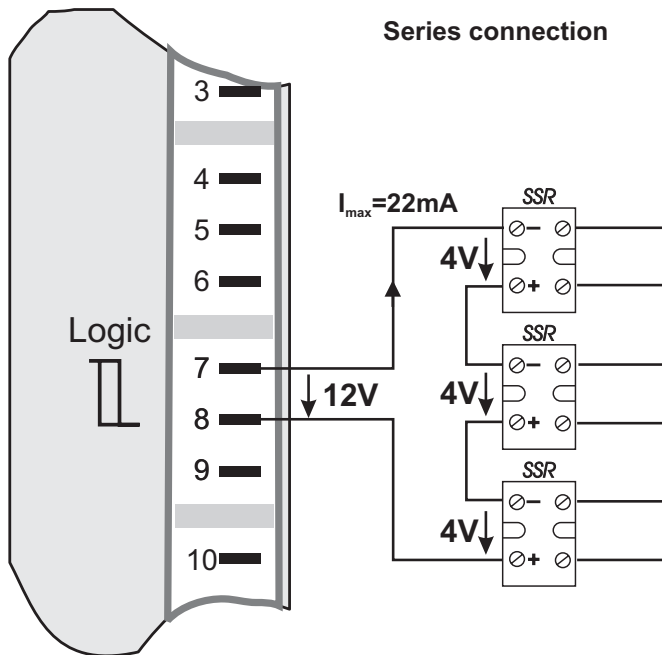

### Parallel connection

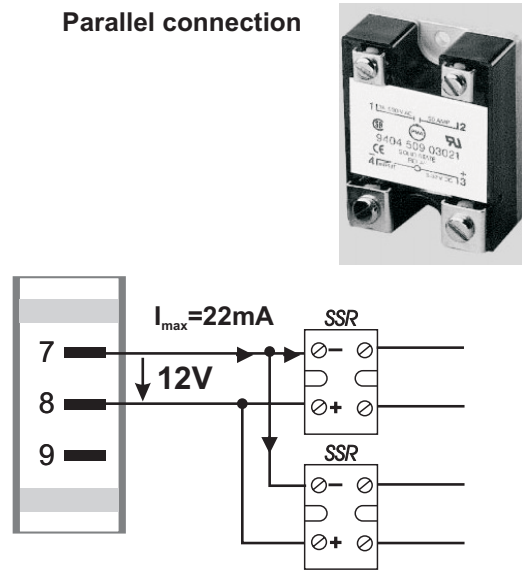



9 RS485 interface (with RS232-RS485 interface converter) \*

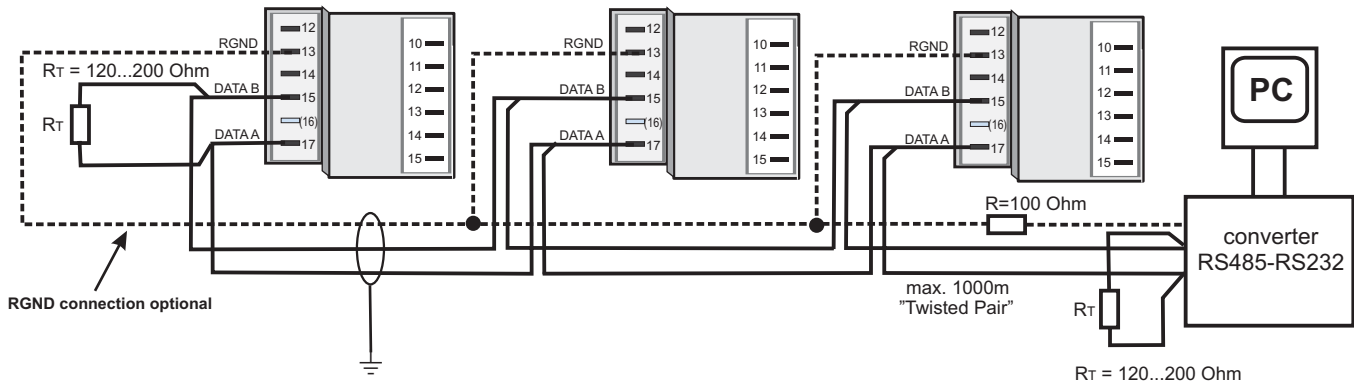

\* Interface description Modbus RTU in separate manual: see page 50.

KS4x-1 connecting example:

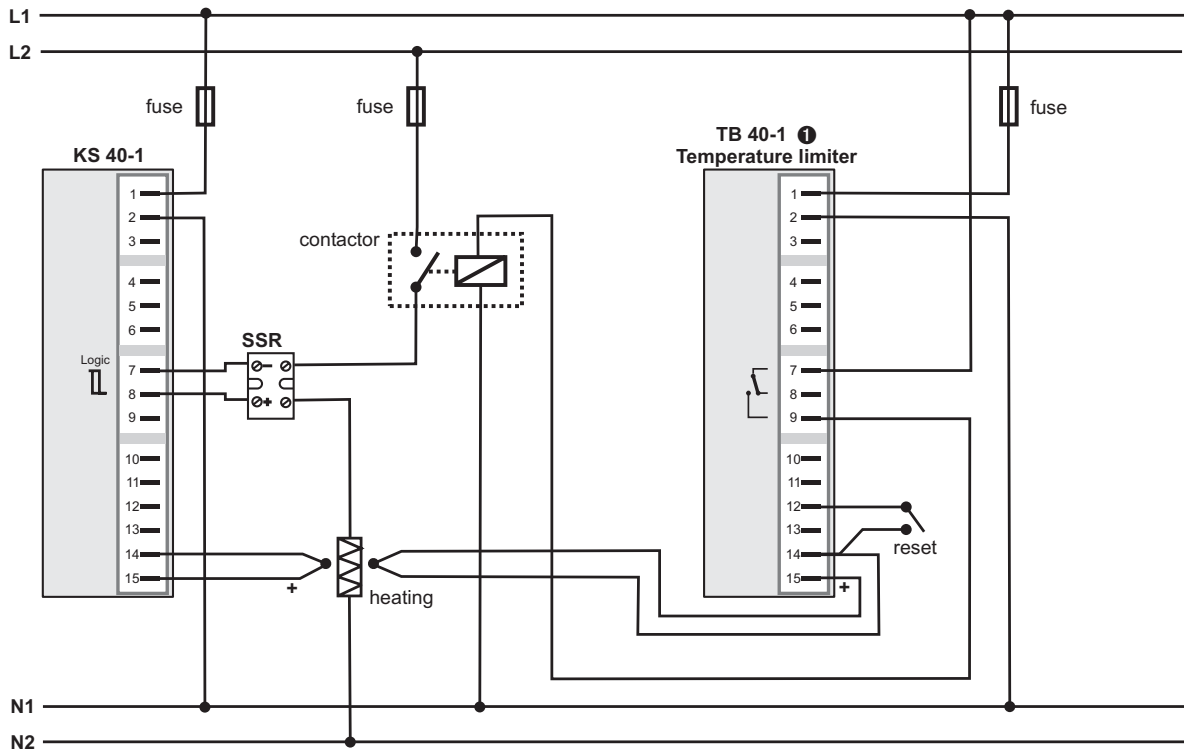

1 TB 40-1 Temperature limiter  
 Standard version (3 relays):  
 TB40-100-0000D-000  
 → other versions on request



**CAUTION:** Using a temperature limiter is recommendable in systems where overtemperature implies a fire hazard or other risks.

**3** Operation

**3.1** Front view

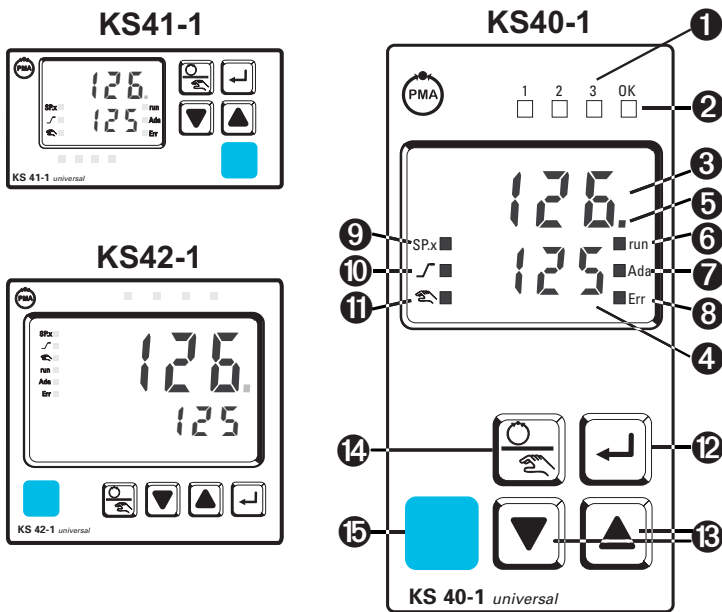

- ❶ Status of switching outputs  
*Out. 1... 3*
- ❷ Lit with limit value 1 (*PRR* / *Lim*) not exceeded
- ❸ Process value display
- ❹ Set-point, controller output
- ❺ Signals *CONF* and *PRR* level
- ❻ Programmer or timer running
- ❼ Self-tuning active
- ❽ Entry in error list
- ❾ Set-point *SP.2* or *SP.E* is effective
- ❿ Set-point gradient effective
- ⓫ Manual/automatic switch-over:  
*Off:* Automatic  
*On:* Manual  
(changing possible)  
*Blinks:* Manual  
(changing not possible  
(→ *CONF* / *Enter* / *Run*))
- ⓬ Enter key:  
calls up extended operating level / error list
- ⓭ Up/down keys:  
changing the set-point or the controller output value
- ⓮ Manual mode /spec. function  
(→ *CONF* / *LOGI* )
- ⓯ PC connection for BlueControl (engineering tool)

LED colours:

- LED 1, 2, 3: yellow
- LED OK: green
- other LEDs: red



In the upper display line, the process value is always displayed. At parameter, configuration, calibration as well as extended operating level, the bottom display line changes cyclically between parameter name and parameter value.

### 3.2 Behaviour after power-on

After supply voltage switch-on, the unit starts with the **operating level**. The unit is in the condition which was active before power-off. If KS4x-1 was in manual mode before power-off, the controller starts with correcting value Y2 after switching on again.

### 3.3 Operating level

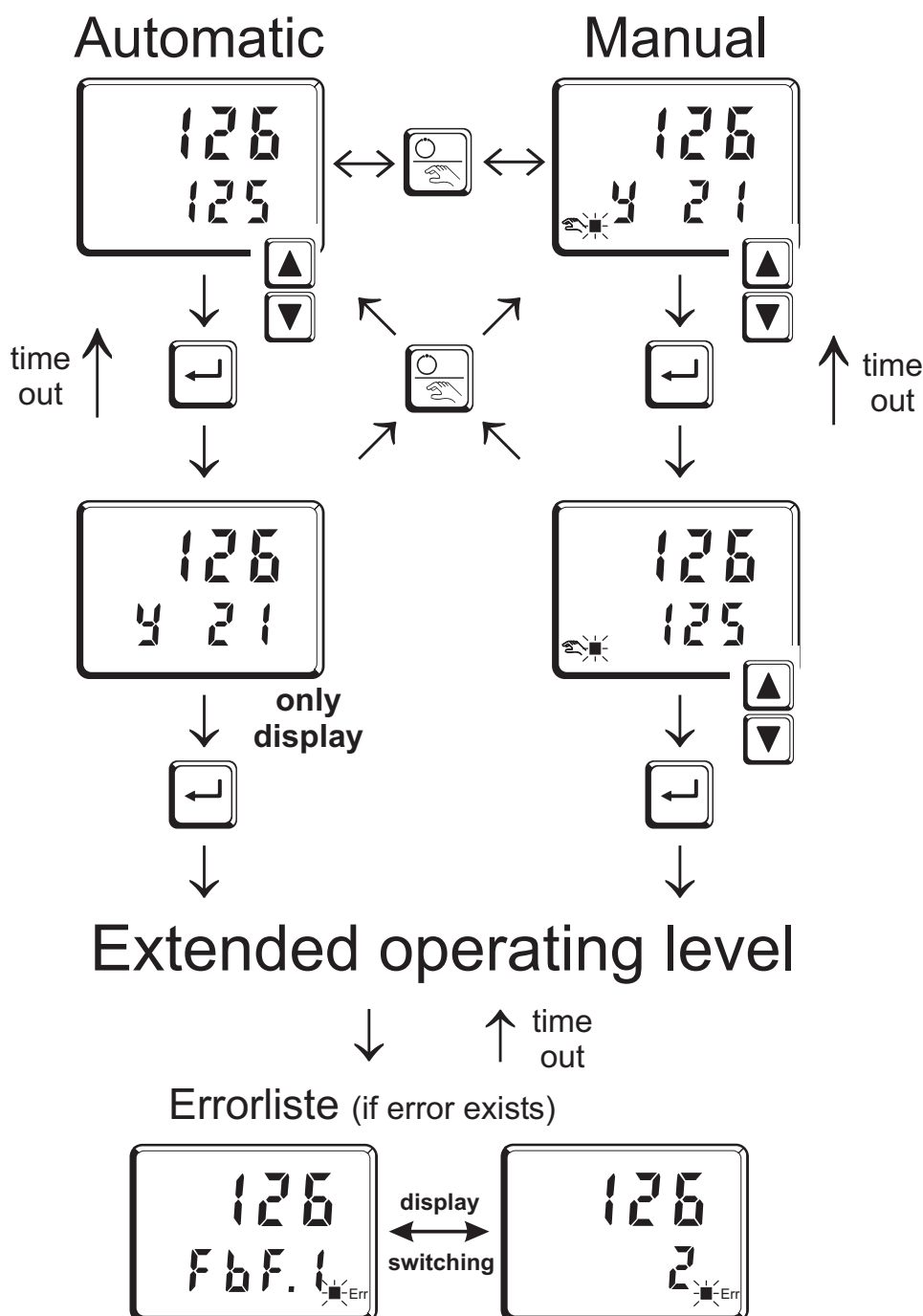

The content of the extended operating level is determined by means of BlueControl (engineering tool). Parameters which are used frequently or the display of which is important can be copied to the extended operating level.



### 3.4 Maintenance manager / Error list

With one or several errors, the extended operating level always starts with the error list. Signalling an actual entry in the error list (alarm, error) is done by the Err LED in the display. To reach the error list press  twice.





Err LED status	Signification	Proceed as follows
blinks (Status 2)	Alarm due to existing error	- Determine the error type in the error list via the error number - Change to status 1 after error removal.
lit (Status 1)	Error removed, Alarm not acknowledged	- Acknowledge the alarm in the error list pressing key  or  - The alarm entry was deleted (Status 0).
off (Status 0)	No error, all alarm entries deleted	- Not visible except when acknowledging

#### Error list:

Name	Description	Cause	Possible remedial action
E.1	Internal error, cannot be removed	- E.g. defective EEPROM	- Contact PMA service - Return unit to our factory
E.2	Internal error, can be reset	- e.g. EMC trouble	- Keep measurement and power supply cables in separate runs - Ensure that interference suppression of contactors is provided
E.4	Hardware error	- Codenumber and hardware are not identical	- Contact PMA service - Elektronik-/Optioncard must be exchanged
FbF.1	Sensor break INP1	- Sensor defective - Faulty cabling	- Replace INP1 sensor - Check INP1 connection
Shk.1	Short circuit INP1	- Sensor defective - Faulty cabling	- Replace INP1 sensor - Check INP1 connection
POL.1	INP1 polarity error	- Faulty cabling	- Reverse INP1 polarity
FbF.2	Sensor break INP2	- Sensor defective - Faulty cabling	- Replace INP2 sensor - Check INP2 connection
Shk.2	Short circuit INP2	- Sensor defective - Faulty cabling	- Replace sensor INP2 - Check INP2 connection
POL.2	INP2 polarity	- Faulty cabling	- Reverse INP2 polarity
HCA	Heating current alarm (HCA)	- Heating current circuit interrupted, $I < HCA$ or $I > HCA$ (dependent of configuration) - Heater band defective	- Check heating current circuit - If necessary, replace heater band
SSr	Heating current short circuit (SSR)	- Current flow in heating circuit with controller off - SSR defective	- Check heating current circuit - If necessary, replace solid-state relay

Name	Description	Cause	Possible remedial action
LOOP	Control loop alarm (LOOP)	- Input signal defective or not connected correctly - Output not connected correctly	- Check heating or cooling circuit - Check sensor and replace it, if necessary - Check controller and switching device
AdRH	Self-tuning heating alarm (ADAH)	- See Self-tuning heating error status	- see Self-tuning heating error status
AdRL	Self-tuning heating alarm cooling (ADAC)	- See Self-tuning cooling error status	- see Self-tuning cooling error status
Lim.1	stored limit alarm 1	- adjusted limit value 1 exceeded	- check process
Lim.2	stored limit alarm 2	- adjusted limit value 2 exceeded	- check process
Lim.3	stored limit alarm 3	- adjusted limit value 3 exceeded	- check process
Inf.1	time limit value message	- adjusted number of operating hours reached	- application-specific
Inf.2	duty cycle message (digital outputs)	- adjusted number of duty cycles reached	- application-specific

-  Saved alarms (Err-LED is lit) can be acknowledged and deleted with the digital input di1/2/3 or the -key.  
Configuration, see page 27: `CONF / LOG1 / Error`
-  If an alarm is still valid that means the cause of the alarm is not removed so far (Err-LED blinks), then other saved alarms can not be acknowledged and deleted.

**Self-tuning heating ( AdRH ) and cooling ( AdRL ) error status:**

Error status	Description	Behaviour
0	No error	
3	Faulty control action	Re-configure controller (inverse ↔ direct)
4	No response of process variable	The control loop is perhaps not closed: check sensor, connections and process
5	Low reversal point	Increase ( AdRH ) max. output limiting <code>Y.H</code> , or decrease ( AdRL ) min. output limiting <code>Y.L</code> .
6	Danger of exceeded set-point (parameter determined)	If necessary, increase (inverse) or reduce (direct) set-point
7	Output step change too small (dy > 5%)	Increase ( AdRH ) max. output limiting <code>Y.H</code> , or reduce ( AdRL ) min. output limiting <code>Y.L</code> .
8	Set-point reserve too small	Increase set-point (invers), reduce set-point (direct) or increase set-point range (→ <code>PRR</code> / <code>SEEP</code> / <code>SP.LD</code> and <code>SP.H</code> )

## 3.5 Self-tuning

For determination of optimum process parameters, self-tuning is possible. After starting by the operator, the controller makes an adaptation attempt, whereby the process characteristics are used to calculate the parameters for fast line-out to the set-point without overshoot.

**The following parameters are optimized when self-tuning:**

**Parameter set 1:**

- $Pb1$  - Proportional band 1 (heating) in engineering units [e.g. °C]
- $t_{i1}$  - Integral time 1 (heating) in [s] → only, unless set to **OFF**
- $t_{d1}$  - Derivative time 1 (heating) in [s] → only, unless set to **OFF**
- $t_{c1}$  - Minimum cycle time 1 (heating) in [s] → only, unless Adt0 was set to “no self-tuning” during configuration by means of BlueControl<sup>®</sup>.
  
- $Pb2$  - Proportional band 2 (cooling) in engineering units [e.g. °C]
- $t_{i2}$  - Integral time 2 (cooling) in [s] → only, unless set to **OFF**
- $t_{d2}$  - Derivative time 2 (cooling) in [s] → only, unless set to **OFF**
- $t_{c2}$  - Minimum cycle time 2 (cooling) in [s] → only, unless Adt0 was set to “no self-tuning” during configuration by means of BlueControl<sup>®</sup>.

### 3.5.1 Preparation for self-tuning

- Adjust the controller measuring range as control range limits. Set values  $r_{n\underline{L}}$  and  $r_{n\underline{H}}$  to the limits of subsequent control. (Configuration → Controller → lower and upper control range limits)  
 $[OFF] \rightarrow [n\underline{L}] \rightarrow r_{n\underline{L}}$  and  $r_{n\underline{H}}$
- Determine which parameter set shall be optimized (see tables above).

### 3.5.2 Self-tuning sequence

The controller outputs 0% correcting variable or **Y.L** and waits, until the process is at rest (see start-conditions on page 8).

Subsequently, a correcting variable step change to 100% is output.

The controller attempts to calculate the optimum control parameters from the process response. If this is done successfully, the optimized parameters are taken over and used for line-out to the set-point.

With a *3-point controller*, this is followed by “cooling”.

After completing the 1st step as described, a correcting variable of -100% (100% cooling energy) is output from the set-point.

After successful determination of the “cooling parameters”, line-out to the set-point is using the optimized parameters.

**Start condition:**

- Rest condition

For process evaluation, a stable condition is required. Therefore, the controller waits until the process has reached a stable condition after self-tuning start.

The rest condition is considered being reached, when the process value oscillation is smaller than  $\pm 0,5\%$  of  $(r_{nLH} - r_{nLL})$ .

**Set-point reserve**

After having come to rest with 0% correcting variable or with  $Y_{L0}$ , the controller requires a sufficient set-point reserve for its self-tuning attempt, in order to avoid overshoot.



**Sufficient set-point reserve:**

inverse controller:(with process value < set-point - (10% of  $SP_{H0} - SP_{L0}$ ))

direct controller:(with process value > set-point + (10% of  $SP_{H0} - SP_{L0}$ ))

**3.5.3 Self-tuning start**

 Self-tuning start can be locked via BlueControl (engineering tool) (  $PL_{OC}$  ).





The operator can start self-tuning at any time. For this, keys  and  must be pressed simultaneously. The AdA LED starts blinking. The controller outputs 0% or  $Y_{L0}$ , waits until the process is at rest and starts self-tuning (AdA LED lit permanently).



After successful self-tuning, the AdA-LED is off and the controller continues operating with the new control parameters.

**3.5.4 Self-tuning cancellation**

**By the operator:**

Self-tuning can always be cancelled by the operator. For this, press  and  key simultaneously. With manual-automatic switch-over configured via  key, self-tuning can also be canceled by actuating  key. The controller continues operating with the old parameters in automatic mode in the first case and in manual mode in the second case.

**By the controller:**





If the Err LED starts blinking whilst self-tuning is running, successful self-tuning is prevented due to the control conditions. In this case, self-tuning was cancelled by the controller.

Dependent of control type, the output status is:

- 3-pnt. stepping controller:  
actuator is closed (0% output)
- 2-pnt./ 3-pnt./ continuous controller:

If self-tuning was started from the automatic mode, the controller output is 0%. With self-tuning started from manual mode, the controller output is  $Y_2$ .

## 3.5.5 Acknowledgement procedures in case of unsuccessful self-tuning

1. Press keys  and  simultaneously:  
The controller continues controlling using the old parameters in automatic mode. The Err LED continues blinking, until the self-tuning error was acknowledged in the error list.
2. Press key  (if configured):  
The controller goes to manual mode. The Err LED continues blinking, until the self-tuning error was acknowledged in the error list.
3. Press key  :  
Display of error list at extended operating level. After acknowledgement of the error message, the controller continues control in automatic mode using the old parameters.

### Cancellation causes:

→ page 13: "Error status self-tuning heating ( *AdRH* ) and cooling ( *AdRC* )"

## 3.5.6 Examples for self-tuning attempts (controller inverse, heating or heating/cooling)

### *Start: heating power switched on*

Heating power Y is switched off (①).  
When the change of process value X was constant during one minute (②), the power is switched on (③).  
At the reversal point, the self-tuning attempt is finished and the new parameter are used for controlling to set-point W.

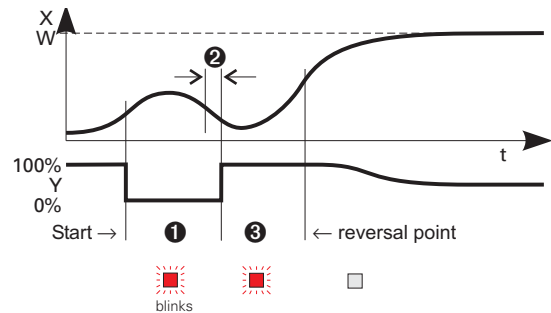

### *Start: heating power switched off*

The controller waits 1,5 minutes (①).  
Heating power Y is switched on (②).  
At the reversal point, the self-tuning attempt is finished and control to the set-point is using the new parameters.

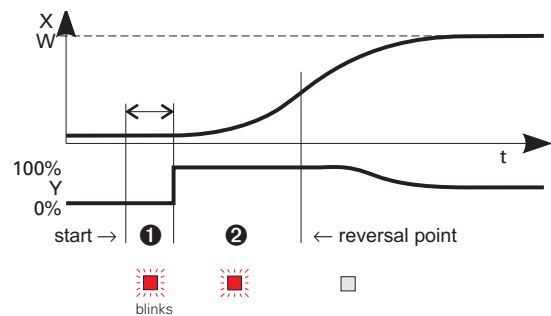



**Start: at set-point**

Heating power Y is switched off (①). If the change of process value X was constant during one minute and the control deviation is > 10% of  $SP.H$  -  $SP.LD$  (②), the power is switched on (③). At the reversal point, the self-tuning attempt is finished, and control to set-point W is using the new parameters.

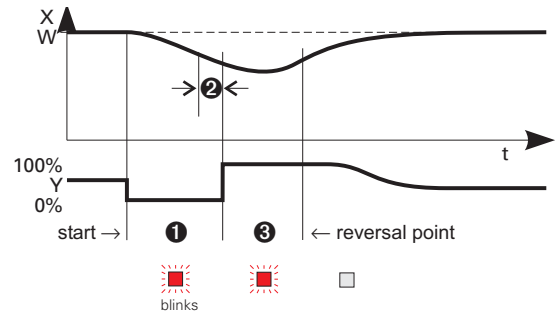

**Three-point controller**

The parameters for heating and cooling are determined in two attempts. The heating power is switched on (①). At reversal point 1, heating parameters  $Pb1$ ,  $t1$ ,  $td1$  and  $t1$  are determined. The process value is lined out to the set-point (②). The cooling power is switched on (③). At reversal point 2, parameters  $Pb2$ ,  $t2$ ,  $td2$  and  $t2$  are determined and the self-tuning attempt is finished. Control to set-point W is using the new parameters.

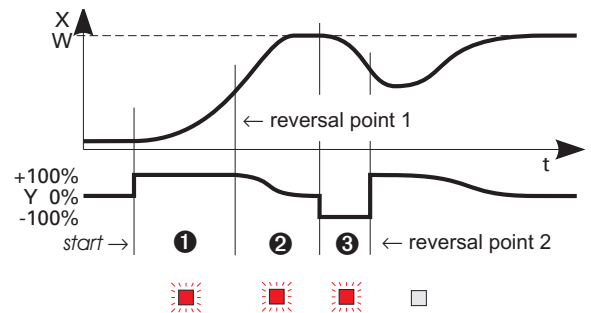

**3.6 Manual tuning**

The optimization aid should be used with units on which the control parameters shall be set without self-tuning.

For this, the response of process variable x after a step change of correcting variable y can be used. Frequently, plotting the complete response curve (0 to 100%) is not possible, because the process must be kept within defined limits. Values  $T_g$  and  $x_{max}$  (step change from 0 to 100 %) or  $\Delta t$  and  $\Delta x$  (partial step response) can be used to determine the maximum rate of increase  $V_{max}$ .

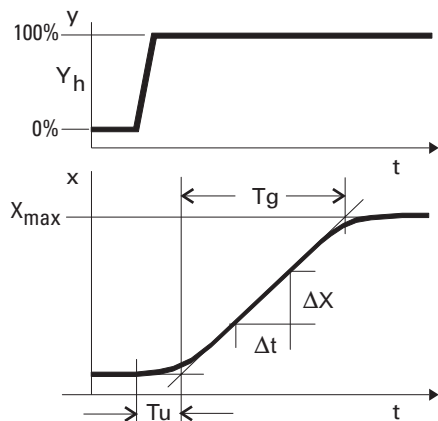

- y = correcting variable
- $Y_h$  = control range
- $T_u$  = delay time (s)
- $T_g$  = recovery time (s)
- $X_{max}$  = maximum process value

$$V_{max} = \frac{X_{max}}{T_g} = \frac{\Delta x}{\Delta t} \triangleq \text{max. rate of increase of process value}$$

The control parameters can be determined from the values calculated for delay time  $T_u$ , maximum rate of increase  $v_{max}$ , control range  $X_h$  and characteristic  $K$  according to the **formulas** given below. Increase  $X_p$ , if line-out to the set-point oscillates.

### Parameter adjustment effects

Parameter	Control	Line-out of disturbances	Start-up behaviour
$Pb1$ higher	increased damping	slower line-out	slower reduction of duty cycle
lower	reduced damping	faster line-out	faster reduction of duty cycle
$td1$ higher	reduced damping	faster response to disturbances	faster reduction of duty cycle
lower	increased damping	slower response to disturbances	slower reduction of duty cycle
$tl1$ higher	increased damping	slower line-out	slower reduction of duty cycle
lower	reduced damping	faster line-out	faster reduction of duty cycle

### Formulas

$$K = v_{max} * T_u$$

With 2-point and 3-point controllers, the cycle time must be adjusted to

$$t1 / t2 \leq 0,25 * T_u$$

controller behavior	$Pb1$ [phy. units]	$td1$ [s]	$tl1$ [s]
PID	$1,7 * K$	$2 * T_u$	$2 * T_u$
PD	$0,5 * K$	$T_u$	OFF
PI	$2,6 * K$	OFF	$6 * T_u$
P	$K$	OFF	OFF
3-point-stepping	$1,7 * K$	$T_u$	$2 * T_u$

## 3.7 Alarm handling

Max. three alarms can be configured and assigned to the individual outputs. Generally, outputs  $Out.1 \dots Out.3$  can be used each for alarm signalling. If more than one signal is linked to one output the signals are OR linked. Each of the 3 limit values  $L_{lim.1} \dots L_{lim.3}$  has 2 trigger points  $H.x$  (Max) and  $L.x$  (Min), which can be switched off individually (parameter = "OFF"). Switching difference  $HYS.x$  of each limit value is adjustable.

① *Operating principle absolut alarm*  
L.I = OFF

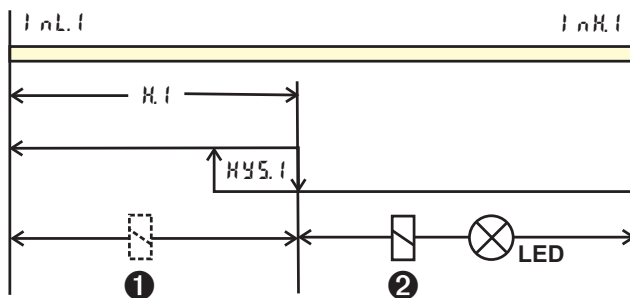

② *Operating principle relative alarm*  
L.I = OFF

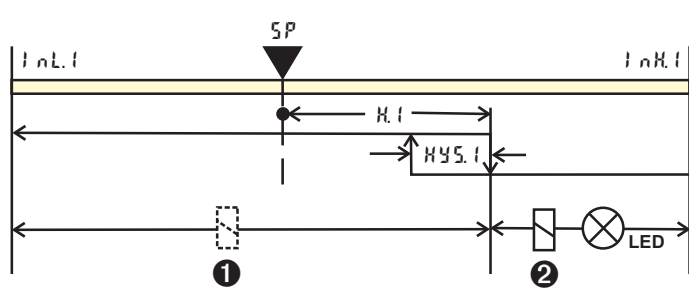

H.I = OFF

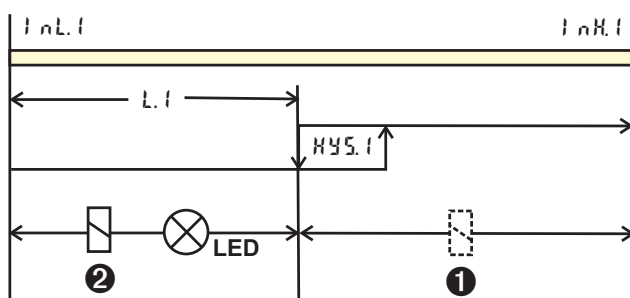

H.I = OFF

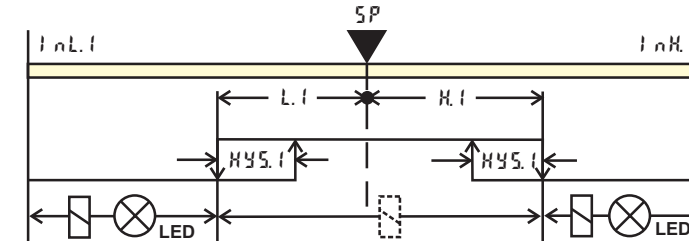
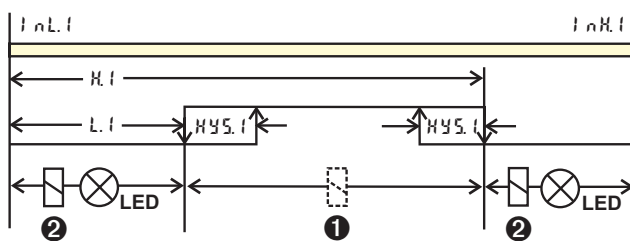
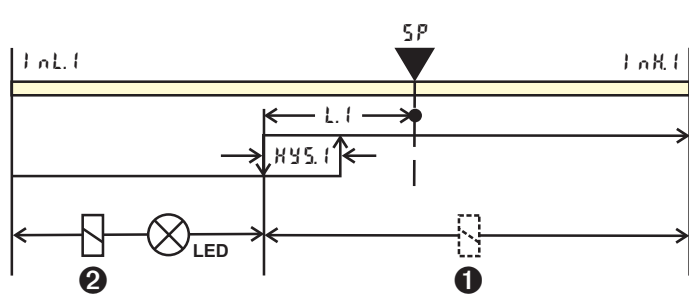

①: normally closed ( $CONF/OUT.X/RACT = 1$ )

②: normally open ( $CONF/OUT.X/RACT = 0$ )



The variable to be monitored can be selected separately for each alarm via configuration

The following variables can be monitored:

- process value
- control deviation xw (process value - set-point)
- control deviation xw + suppression after start-up or set-point change
- effective set-point Weff
- correcting variable y (controller output)

- i** If measured value monitoring + alarm status storage is chosen ( $CONF / L_{in} / Func.X = 2$ ), the alarm relay remains switched on until the alarm is reset in the error list ( $L_{in} 1..3 = 1$ ).

## 3.8 Operating structure

After supply voltage switch-on, the controller starts with the **operating levels**. The controller status is as before power off.

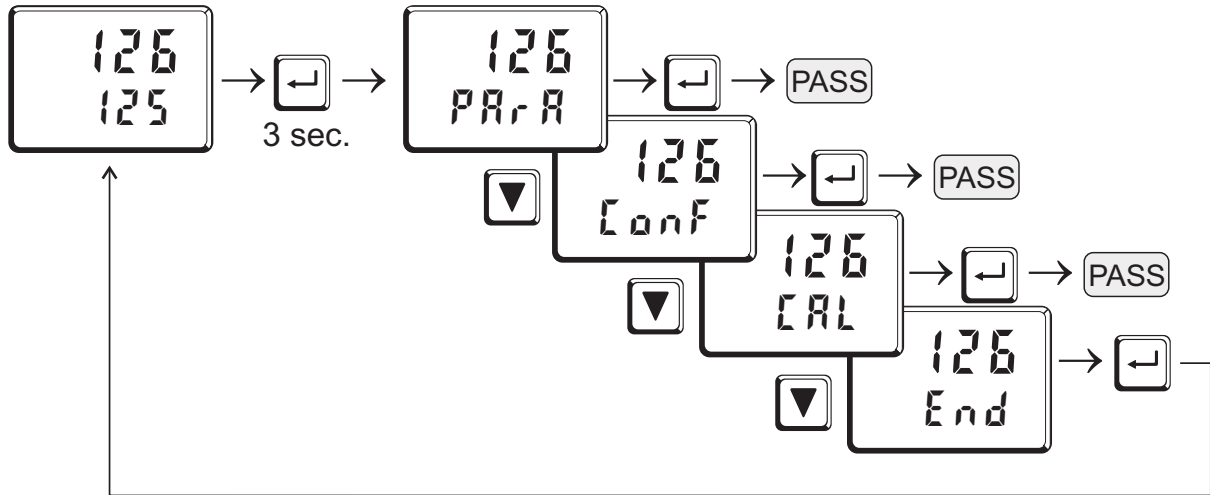

- i** **PARR** - level: At **PARR** - level, the right decimal point of the upper display line is *lit continuously*.
- i** **CONF** - level: At **CONF** - level, the right decimal point of the upper display line *blinks*.

**PASS** When safety switch **Loc** is open, only the levels enabled by means of BlueControl (engineering tool) are visible and accessible by entry of the password adjusted by means of BlueControl (engineering tool). Individual parameters accessible without password must be copied to the extended operating level.

**Factory setting:** Safety switch **Loc** closed: all levels accessible without restriction, password **PASS = OFF**.

Safety switch <b>Loc</b>	Password entered with BluePort®	Function disabled or enabled with BluePort®	Access via the instrument front panel:
closed	OFF / password	disabled / enabled	<b>enabled</b>
open	OFF / password	disabled	<b>disabled</b>
open	OFF	enabled	<b>enabled</b>
open	Password	enabled	<b>enabled after password entry</b>

**4** Configuration level

**4.1** Configuration survey

CONF Configuration level										
	Enter Control and self-tuning	InP.1 Input 1	InP.2 Input 2	Lim Limit value functions	OUT.1 Output 1	OUT.2 Output 2	OUT.3 Output 3	DIGI Digital inputs	Display, operation, interface	End
▲	SPFn	StYP	IFnc	Fnc.1	ORct	See output 1	QtYP	L.r	bAud	
▼	b.t.	SL in	StYP	Src.1	Y.1		ORct	SP.2	Addr	
	CFnc	Corr		Fnc.2	Y.2		Y.1	SPE	PrtY	
	nAn			Src.2	L.in.1		Y.2	Y.2	dEL Y	
	ARct			Fnc.3	L.in.2		L.in.1	nAn	Unit	
	FRIL			Src.3	L.in.3		L.in.2	COFF	dP	
	rnGL			HCRAL	LPRAL		L.in.3	nLoc	CdEL	
	rnGH			LPRAL	HCRAL		LPRAL	Errr		
				HCRAL	HCRAL		HCRAL	Prun		
				t.in.2	HCRAL		HCRAL	d.Fn		
				P.End	t.in.2	t.in.2				
				FR.v1	P.End	P.End				
				FR.v2	FR.v1	FR.v1				
					FR.v2	FR.v2				
					Out.0	Out.0				
					Out.1	Out.1				
					QSrc	QSrc				

**Adjustment:**

- The configurations can be adjusted by means of keys ▲▼ .
- Transition to the next configuration is by pressing key ↵ .
- After the last configuration of a group, donE is displayed and followed by automatic change to the next group

**i** Return to the beginning of a group is by pressing the ↵ key for 3 sec.

## 4.2 Configuration

### Enter

Name	Value range	Description	Default
<b>SPFn</b>		<b>Basic configuration of setpoint processing</b>	0
	0	set-point controller can be switched over to external set-point ( $\rightarrow$ LOGI / SPE)	
	1	program controller	
	2	timer, mode 1 (bandwidth-controlled, switched off at the end)	
	3	timer, mode 2 (bandwidth-controlled, set-point remains active at the end)	
	4	timer, mode 3 (switched off at the end)	
	5	timer, mode 4 (set-point remains active at the end)	
	6	timer, mode 5 (switch-on delay)	
	7	timer, mode 6 (set-point switch-over)	
<b>b.ti</b>	0...9999	<b>Timer tolerance band for timer mode 1, 2 and 6. The timer starts when process value = setpoint <math>\pm</math> b.ti</b>	5
<b>CFnc</b>		<b>Control behaviour (algorithm)</b>	1
	0	on/off controller or signaller with one output	
	1	PID controller (2-point and continuous)	
	2	$\Delta$ / Y / Off, or 2-point controller with partial/full load switch-over	
	3	2 x PID (3-point and continuous)	
	4	3-point stepping controller	
<b>nAn</b>		<b>Manual operation permitted</b>	0
	0	no	
	1	yes (see also LOGI / nAn)	
<b>CRct</b>		<b>Method of controller operation</b>	0
	0	inverse, e.g. heating	
	1	direct, e.g. cooling	
<b>FRIL</b>		<b>Behaviour at sensor break</b>	1
	0	controller outputs switched off	
	1	$y = Y2$	
	2	$y =$ mean output. The maximum permissible output can be adjusted with parameter $YnH$ . To prevent determination of inadmissible values, mean value formation is only if the control deviation is lower than parameter $L.Yn$ .	
<b>rnGL</b>	-1999...9999	<b>X0 (low limit range of control) ①</b>	0
<b>rnGH</b>	-1999...9999	<b>X100 (high limit range of control) ①</b>	900
<b>Adt0</b>		<b>Optimization of T1, T2 (only visible with BlueControl!)</b>	0
	0	Automatic optimization	
	1	No optimization	

① **rnGL** and **rnGH** are indicating the range of control on which e.g. the self-tuning is referring

## INP.1

Name	Value range	Description	Default
SEYP		<b>Sensor type selection</b>	1
	0	thermocouple type L (-100...900°C), Fe-CuNi DIN	
	1	thermocouple type J (-100...1200°C), Fe-CuNi	
	2	thermocouple type K (-100...1350°C), NiCr-Ni	
	3	thermocouple type N (-100...1300°C), Nicrosil-Nisil	
	4	thermocouple type S (0...1760°C), PtRh-Pt10%	
	5	thermocouple type R (0...1760°C), PtRh-Pt13%	
	20	Pt100 (-200.0 ... 100.0 °C)	
	21	Pt100 (-200.0 ... 850.0 °C)	
	22	Pt1000 (-200.0 ... 200.0 °C)	
	23	special 0...4500 Ohm (pre-defined as KTY11-6)	
	30	0...20mA / 4...20mA ①	
40	0...10V / 2...10V ①		
SLIN		<b>Linearization (only at SEYP = 23 (KTY 11-6), 30 (0..20mA) and 40 (0..10V) adjustable)</b>	0
	0	none	
CORR	1	Linearization to specification. Creation of linearization table with BlueControl (engineering tool) possible. The characteristic for KTY 11-6 temperature sensors is preset.	
	2	2-point correction (at ERR level)	
	3	Scaling (at PRR level)	
	0	Without scaling	
fAI1		<b>Measured value correction / scaling</b>	0
	0	Without scaling	
	1	Offset correction (at ERR level)	
	2	2-point correction (at ERR level)	
	3	Scaling (at PRR level)	
fAI1		<b>Forcing INP1 (only visible with BlueControl!)</b>	0
	0	No forcing	
	1	Forcing via serial interface	

## INP.2

Name	Value range	Description	Default
IFnc		<b>Function selection of INP2</b>	1
	0	no function (subsequent input data are skipped)	
	1	heating current input	
SEYP	2	external set-point (SPE)	
		<b>Sensor type selection</b>	31
	30	0...20mA / 4...20mA ①	
fAI2	31	0...50mA AC ①	
		<b>Forcing INP2 (only visible with BlueControl!)</b>	0
	0	No forcing	
	1	Forcing via serial interface	

## Lim

Name	Value range	Description	Default
<b>Func.1</b>		<b>Function of limit 1/2/3</b>	1
Func.2	0	switched off	
Func.3	1	measured value monitoring	
	2	Measured value monitoring + alarm status storage. A stored limit value can be reset via error list,  -key or a digital input (→ LOG1 / Error).	
<b>Src.1</b>		<b>Source of limit 1/2/3</b>	1
Src.2	0	process value	
Src.3	1	control deviation xw (process value - set-point)	
	2	control deviation xw (with suppression after start-up and set-point change)	
	6	effective set-point Weff	
	7	correcting variable y (controller output)	
<b>HC.AL</b>		<b>Alarm heat current function (INP2)</b>	0
	0	switched off	
	1	Overload short circuit monitoring	
	2	Break and short circuit monitoring	
<b>LP.AL</b>		<b>Monitoring of control loop interruption for heating</b>	0
	0	switched off / inactive	
	1	active If $t_{1,1} \neq 0$ LOOP alarm is inactive!	
Hour	OFF..999999	<b>Operating hours</b> (only visible with BlueControl!)	OFF
Swit	OFF..999999	<b>Output switching cycles</b> (only visible with BlueControl!)	OFF

## Out.1

Name	Value range	Description	Default
<b>OR.ct</b>		<b>Method of operation of output OUT1</b>	0
	0	direct / normally open	
	1	inverse / normally closed	
<b>Y.1</b>		<b>Controller output Y1/Y2</b>	1
Y.2	0	not active	
	1	active	
<b>Lim.1</b>		<b>Limit 1/2/3 signal</b>	0
Lim.2	0	not active	
Lim.3	1	active	
<b>LP.AL</b>		<b>Interruption alarm signal (LOOP)</b>	0
	0	not active	
	1	active	
<b>HC.AL</b>		<b>Heat current alarm signal</b>	0
	0	not active	
	1	active	

❶ with current and voltage input signals, scaling is required (see chapter 5.3)



**Resetting the controller configuration to factory setting (Default)**

→ chapter 12.1 (page 56)



Name	Value range	Description	Default
H.C.S.C		<b>Solid state relay (SSR) short circuit signal</b>	0
	0	not active	
	1	active	
t. i.n.E		<b>Timer end signal</b>	0
	0	not active	
	1	active	
P.End		<b>Programmer end signal</b>	0
	0	not active	
	1	active	
F.A.1 F.A.2		<b>INP1/ INP2 error signal</b>	0
	0	not active	
	1	active	
fOut		<b>Forcing OUT1 (only visible with BlueControl!)</b>	0
	0	No forcing	
	1	Forcing via serial interface	

### Out.2

Configuration parameters Out.2 as Out.1 except for: Default Y.1 = 0 Y.2 = 1

### Out.3

Name	Value range	Description	Default
O.T.Y.P		<b>Signal type selection OUT3</b>	0
	0	relay / logic (only visible with current/logic voltage)	
	1	0 ... 20 mA continuous (only visible with current/logic/volt.)	
	2	4 ... 20 mA continuous (only visible with current/logic/volt.)	
	3	0...10 V continuous (only visible with current/logic/voltage)	
	4	2...10 V continuous (only visible with current/logic/voltage)	
	5	transmitter supply (only visible without OPTION)	
O.R.c.t		<b>Method of operation of output OUT3 (only visible when O.TYP=0)</b>	1
	0	direct / normally open	
	1	inverse / normally closed	
Y.1 Y.2		<b>Controller output Y1/Y2 (only visible when O.TYP=0)</b>	0
	0	not active	
	1	active	
L.i.n.1 L.i.n.2 L.i.n.3		<b>Limit 1/2/3 signal (only visible when O.TYP=0)</b>	1
	0	not active	
	1	active	
L.P.AL		<b>Interruption alarm signal (LOOP) (only visible when O.TYP=0)</b>	0
	0	not active	
	1	active	
H.C.AL		<b>Heat current alarm signal (only visible when O.TYP=0)</b>	0
	0	not active	
	1	active	

Name	Value range	Description	Default
H.C.S.C		<b>Solid state relay (SSR) short circuit signal (only visible when O.TYP=0)</b>	0
	0	not active	
	1	active	
t. n.E		<b>Timer end signal (only visible when O.TYP=0)</b>	0
	0	not active	
	1	active	
P.E.n.d		<b>Programmer end signal (only visible when O.TYP=0)</b>	0
	0	not active	
	1	active	
F.A.l.1 F.A.l.2		<b>INP1/ INP2 error (only visible when O.TYP=0)</b>	1
	0	not active	
	1	active	
Out.0	-1999...9999	<b>Scaling of the analog output for 0% (0/4mA or 0/2V, only visible when O.TYP=1..5)</b>	0
Out.1	-1999...9999	<b>Scaling of the analog output for 100% (20mA or 10V, only visible when O.TYP=1..5)</b>	100
O.S.r.c		<b>Signal source of the analog output OUT3 (only visible when O.TYP=1..5)</b>	1
	0	not used	
	1	controller output y1 (continuous)	
	2	controller output y2 (continuous)	
	3	process value	
	4	effective set-point Weff	
fOut		<b>Forcing OUT3 (only visible with BlueControl!)</b>	0
	0	No forcing	
	1	Forcing via serial interface	





### Method of operation and usage of output Out.1 to Out.3:

Is more than one signal chosen active as source, those signals are OR-linked.

## LOGI

Name	Value range	Description	Default
L.s.r		<b>Local / Remote switching (Remote: adjusting of all values by front keys is blocked)</b>	0
	0	no function (switch-over via interface is possible)	
	1	active	
	2	DI1	
	3	DI2 (only visible with OPTION)	
	4	DI3 (only visible with OPTION)	
SP.2		<b>Switching to second setpoint SP.2</b>	0
	0	no function (switch-over via interface is possible)	
	2	DI1	
	3	DI2 (only visible with OPTION)	
	4	DI3 (only visible with OPTION)	

Name	Value range	Description	Default
SP.E		<b>Switching to external setpoint SP.E</b>	0
	0	no function (switch-over via interface is possible)	
	1	active	
	2	DI1	
	3	DI2 (only visible with OPTION)	
	4	DI3 (only visible with OPTION)	
Y2		<b>Y/Y2 switching</b>	0
	0	no function (switch-over via interface is possible)	
	2	DI1	
	3	DI2 (only visible with OPTION)	
	4	DI3 (only visible with OPTION)	
	6	 key	
A.M		<b>Automatic/manual switching</b>	0
	0	no function (switch-over via interface is possible)	
	1	always activated (manual station)	
	2	DI1	
	3	DI2 (only visible with OPTION)	
	4	DI3 (only visible with OPTION)	
C.OFF		<b>Switching off the controller</b>	0
	0	no function (switch-over via interface is possible)	
	2	DI1	
	3	DI2 (only visible with OPTION)	
	4	DI3 (only visible with OPTION)	
	6	 key	
h.Loc		<b>Blockage of hand function</b>	0
	0	no function (switch-over via interface is possible)	
	2	DI1	
	4	DI3 (only visible with OPTION)	
Err.r		<b>Reset of all error list entries</b>	0
	0	no function (switch-over via interface is possible)	
	2	DI1	
	3	DI2 (only visible with OPTION)	
	4	DI3 (only visible with OPTION)	
	6	 key	
P.run		<b>Programmer Run/Stop (see page 44)</b>	0
	0	no function (switch-over via interface is possible)	
	2	DI1	
	3	DI2 (only visible with OPTION)	
	4	DI3 (only visible with OPTION)	
d.i.Fn		<b>Function of digital inputs (valid for all inputs)</b>	0
	0	direct	
	1	inverse	
	2	toggle key function	
fDI1		<b>Forcing di1 (only visible with BlueControl!)</b>	0
	0	No forcing	
	1	Forcing via serial interface	

## Configuration level

Name	Value range	Description	Default
fDI2		<b>Forcing di2</b> (only visible with BlueControl!)	0
	0	No forcing	
	1	Forcing via serial interface	
fDI3		<b>Forcing di3</b> (only visible with BlueControl!)	0
	0	No forcing	
	1	Forcing via serial interface	

## okhr

Name	Value range	Description	Default
bAud		<b>Baudrate of the interface</b> (only visible with OPTION)	2
	0	2400 Baud	
	1	4800 Baud	
	2	9600 Baud	
	3	19200 Baud	
Addr	1...247	<b>Address on the interace</b> (only visible with OPTION)	1
Prty		<b>Parity</b> (only visible with OPTION)	1
	0	no parity (2 stop bits)	
	1	even parity	
	2	odd parity	
dELY	0...200	<b>Delay of response signal [ms]</b> (only visible with OPTION)	0
Unit		<b>Unit</b>	1
	0	without unit	
	1	°C	
	2	°F	
dP		<b>Decimal point</b> (max. number of digits behind the decimal point)	0
	0	no digit behind the decimal point	
	1	1 digit behind the decimal point	
	2	2 digits behind the decimal point	
	3	3 digits behind the decimal point	
LDL	0..200	<b>Modem delay [ms]</b>	0
FrEq		<b>Switching 50 Hz / 60 Hz</b> (only visible with BlueControl!)	0
	0	50 Hz	
	1	60 Hz	
ICof		<b>Block controller off</b> (only visible with BlueControl!)	0
	0	Released	
	1	Blocked	
IAda		<b>Block auto tuning</b> (only visible with BlueControl!)	0
	0	Released	
	1	Blocked	
IExo		<b>Block extended operating level</b> (only visible with BlueControl!)	0
	0	Released	
	1	Blocked	
Pass	OFF...9999	<b>Password</b> (only visible with BlueControl!)	OFF

Name	Value range	Description	Default
IPar		<b>Block parameter level</b> (only visible with BlueControl!)	1
	0	Released	
	1	Blocked	
ICnf		<b>Block configuration level</b> (only visible with BlueControl!)	1
	0	Released	
	1	Block	
ICal		<b>Block calibration level</b> (only visible with BlueControl!)	1
	0	Released	
	1	Blocked	



**BlueControl - the engineering tool for the BluePort® controller series**

3 engineering tools with different functionality facilitating KS4x-1 configuration and parameter setting are available (see chapter 10: *Accessory equipment with ordering information*).

In addition to configuration and parameter setting, the engineering tools are used for data acquisition and offer long-term storage and print functions. The engineering tools are connected to KS4x-1 via the front-panel interface "BluePort®" by means of PC (Windows 95 / 98 / NT) and a PC adaptor.

Description BlueControl: see chapter 9: *BlueControl* (page 49)

**4.3 Set-point processing**

The set-point processing structure is shown in the following picture:

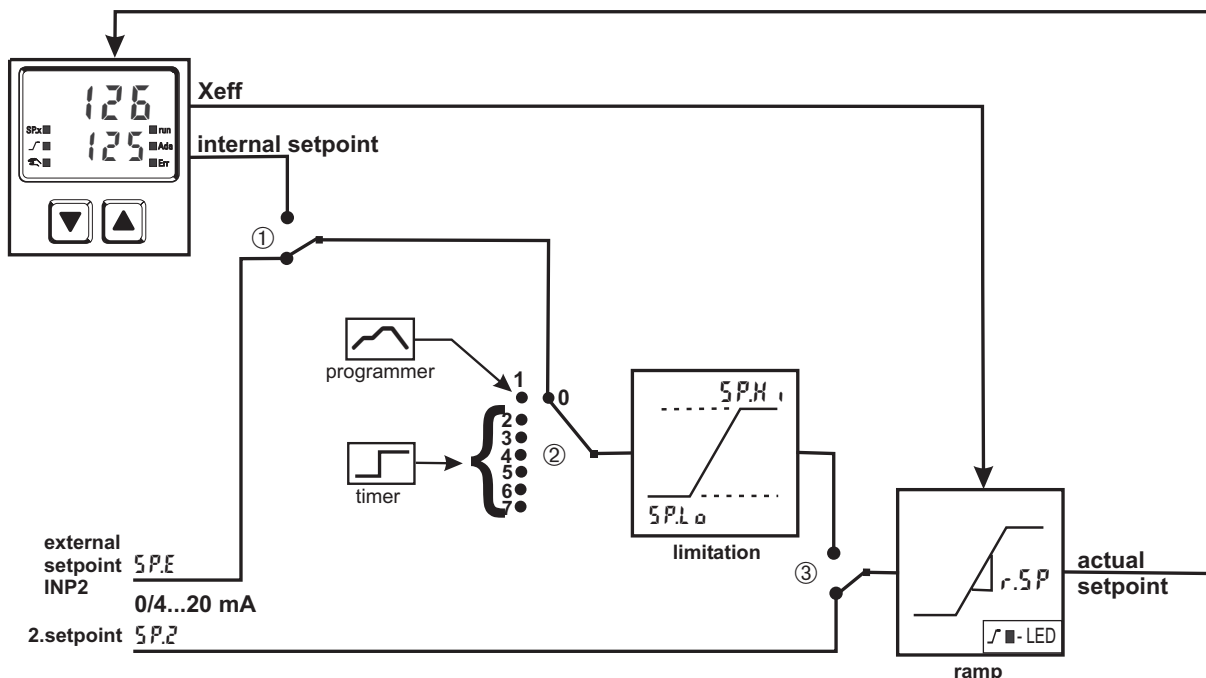

**Index:**

- ① : int/ext-setpoint switching
- ② : configuration  $S.P.n$
- ③ :  $S.P.$  /  $S.P.2$  switching

**The ramp starts at process value with the following switchings:**

- int / ext-setpoint switching
- $S.P.$  /  $S.P.2$  switching
- Manual- / Automatic switching
- at power on

4.4 Configuration examples

4.4.1 On-Off controller / Signaller (inverse)

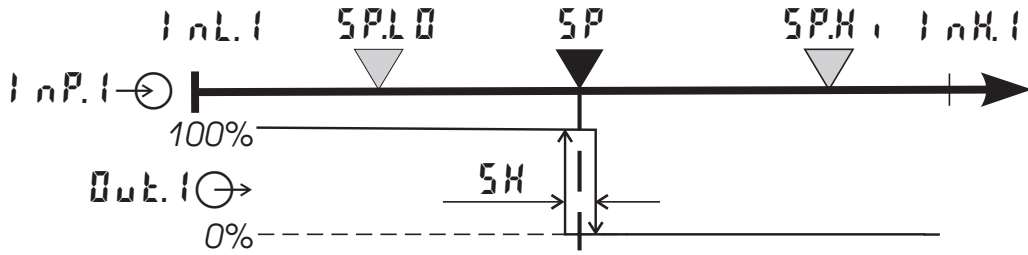

CONF / ENTR:	SPFN = 0	set-point controller
	CFNC = 0	signaller with one output
	CACT = 0	inverse action
		(e.g. heating applications)
CONF / OUT.1:	OACT = 0	action Out.1 direct
	Y1 = 1	control output Y1 active
PARA / ENTR:	SH = 0...9999	switching difference (symmetrical to the trigger point)
PARA / SEEP:	SP.L0 = -1999...9999	set-point limit low for Weff
	SP.H. = -1999...9999	set-point limit high for Weff

**i** For direct signaller action, the controller action must be changed (CONF / ENTR / CACT = 1)

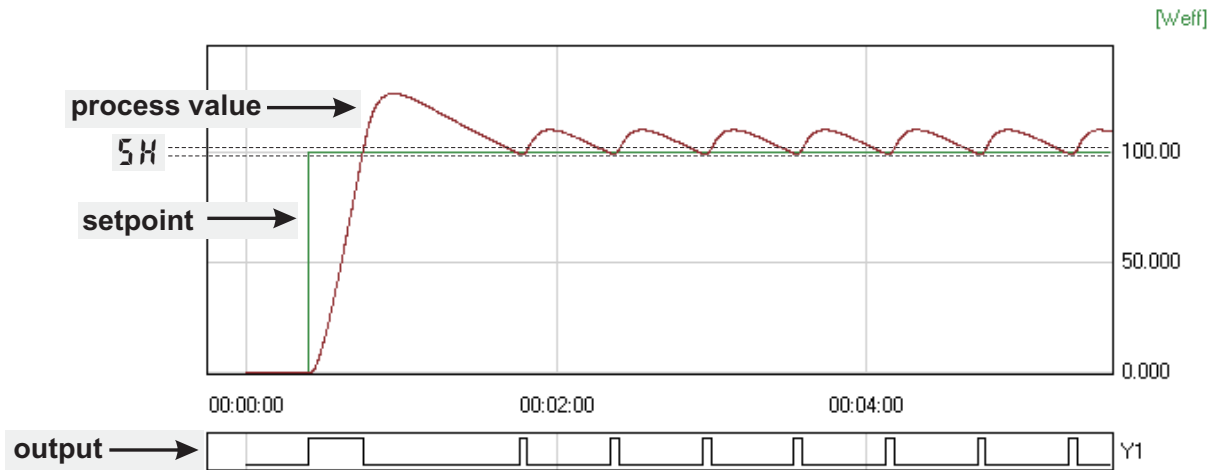

### 4.4.2 2-point controller (inverse)

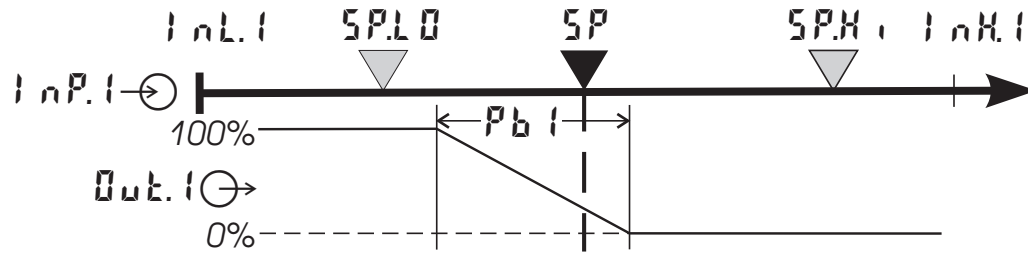

CONF / Contr:	SPFn = 0	set-point controller
	CFnc = 1	2-point controller (PID)
	CAct = 0	inverse action (e.g. heating applications)
CONF / Out.1:	OAct = 0	action Out.1 direct
	Y1 = 1	control output Y1 active
PARA / Contr:	Pbl = 0,1...9999	proportional band 1 (heating) in units of phys. quantity (e.g. °C)
	t1 = 1...9999	integral time 1 (heating) in sec.
	td1 = 1...9999	derivative time 1 (heating) in sec.
	t1 = 0,4...9999	min. cycle time 1 (heating)
PARA / SEtP:	SP.L0 = -1999...9999	set-point limit low for Weff
	SP.H0 = -1999...9999	set-point limit high for Weff

**i** For direct action, the controller action must be changed (CONF / Contr / CAct = 1).

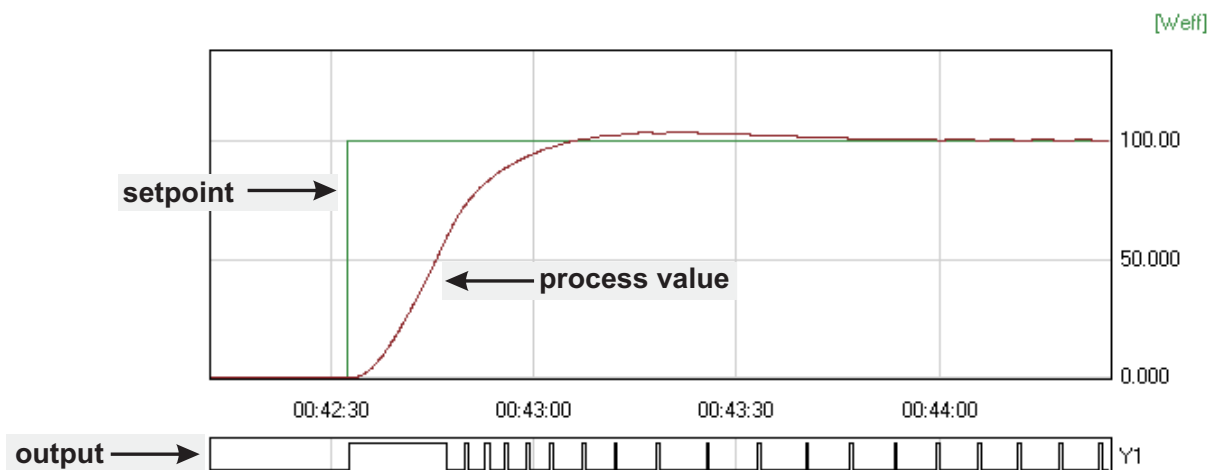

4.4.3 3-point controller (relay & relay)

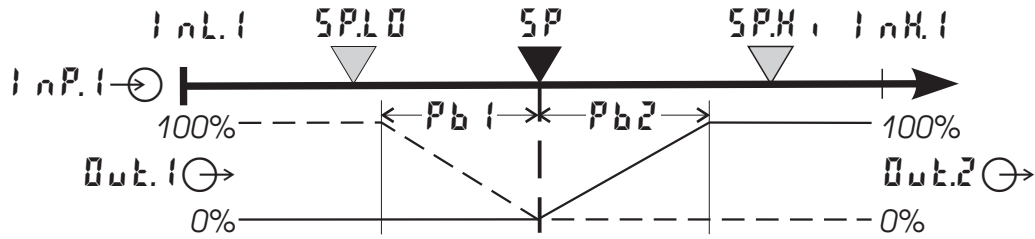

<code>ConF / Contr:</code>	<code>SPFn</code>	<code>= 0</code>	set-point controller
	<code>CFnc</code>	<code>= 3</code>	3-point controller (2xPID)
	<code>CAct</code>	<code>= 0</code>	action inverse (e.g. heating applications)
<code>ConF / Out.1:</code>	<code>ORct</code>	<code>= 0</code>	action <code>Out.1</code> direct
	<code>y1</code>	<code>= 1</code>	control output Y1 active
	<code>y2</code>	<code>= 0</code>	control output Y2 not active
<code>ConF / Out.2:</code>	<code>ORct</code>	<code>= 0</code>	action <code>Out.2</code> direct
	<code>y1</code>	<code>= 0</code>	control output Y1 not active
	<code>y2</code>	<code>= 1</code>	control output Y2 active
<code>PARA / Contr:</code>	<code>Pb1</code>	<code>= 0,1...9999</code>	proportional band 1 (heating) in units of phys. quantity (e.g. °C)
	<code>Pb2</code>	<code>= 0,1...9999</code>	proportional band 2 (cooling) in units of phys. quantity (e.g. °C)
	<code>t11</code>	<code>= 1...9999</code>	integral time 1 (heating) in sec.
	<code>t12</code>	<code>= 1...9999</code>	derivative time 2 (cooling) in sec.
	<code>td1</code>	<code>= 1...9999</code>	integral time 1 (heating) in sec.
	<code>td2</code>	<code>= 1...9999</code>	derivative time 2 (cooling) in sec.
	<code>t1</code>	<code>= 0,4...9999</code>	min. cycle time 1 (heating)
	<code>t2</code>	<code>= 0,4...9999</code>	min. cycle time 2 (cooling)
	<code>SK</code>	<code>= 0...9999</code>	neutr. zone in units of phys.quantity
<code>PARA / SEtP:</code>	<code>SP.LO</code>	<code>= -1999...9999</code>	set-point limit low for Weff
	<code>SP.H.</code>	<code>= -1999...9999</code>	set-point limit high for Weff



### 4.4.4 3-point stepping controller (relay & relay)

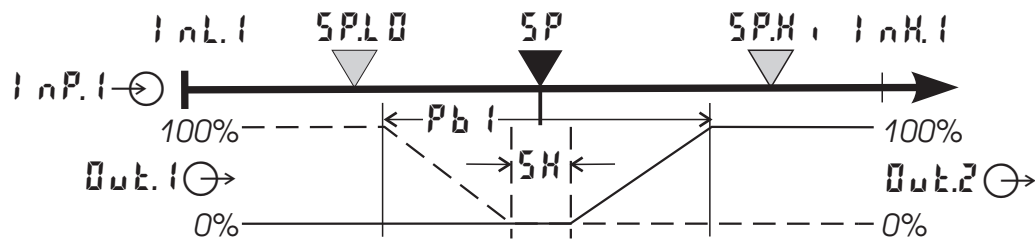

<b>CONF / Contr:</b>	<b>SPFn</b> = 0	set-point controller
	<b>CFnc</b> = 4	3-point stepping controller
	<b>CAct</b> = 0	inverse action (e.g. heating applications)
<b>CONF / Out.1:</b>	<b>ORct</b> = 0	action <b>Out.1</b> direct
	<b>Y1</b> = 1	control output Y1 active
	<b>Y2</b> = 0	control output Y2 not active
<b>CONF / Out.2:</b>	<b>ORct</b> = 0	action <b>Out.2</b> direct
	<b>Y1</b> = 0	control output Y1 not active
	<b>Y2</b> = 1	control output Y2 active
<b>PARA / Contr:</b>	<b>Pb1</b> = 0,1...9999	proportional band 1 (heating) in units of phys. quantity (e.g. °C)
	<b>t i 1</b> = 1...9999	integral time 1 (heating) in sec.
	<b>t d 1</b> = 1...9999	derivative time 1 (heating) in sec.
	<b>t 1</b> = 0,4...9999	min. cycle time 1 (heating)
	<b>SH</b> = 0...9999	neutral zone in units of phys. quantity
	<b>tP</b> = 0,1...9999	min. pulse length in sec.
	<b>t t</b> = 3...9999	actuator travel time in sec.
<b>PARA / SEtP:</b>	<b>SP.L0</b> = -1999...9999	set-point limit low for Weff
	<b>SP.H0</b> = -1999...9999	set-point limit high for Weff

**i** For direct action of the 3-point stepping controller, the controller output action must be changed (**CONF / Contr / CAct** = 1).

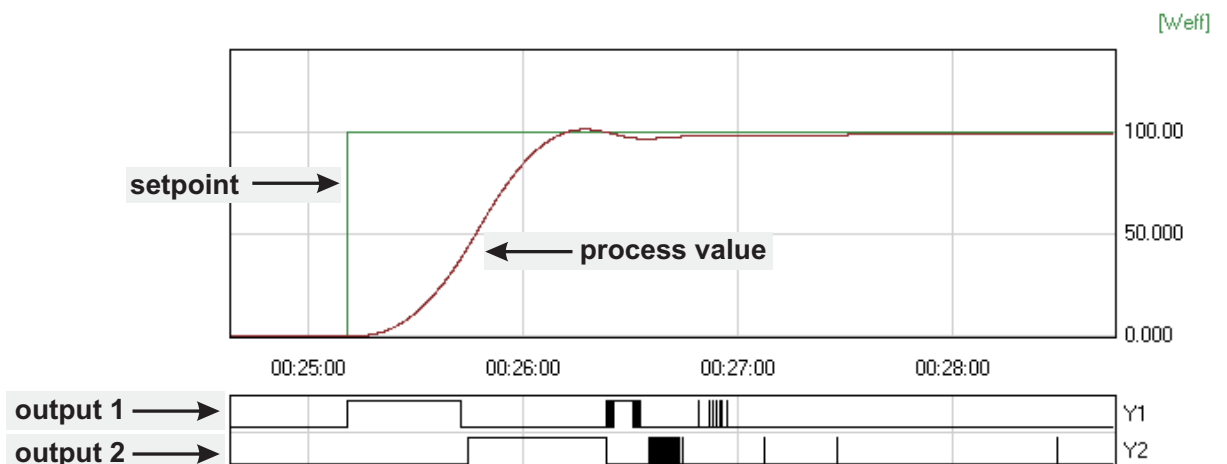

## 4.4.5 Continuous controller (inverse)

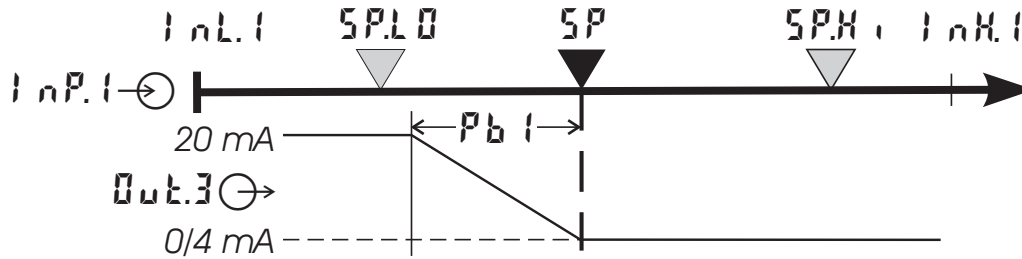

$CONF / ENTR:$	$SPFn = 0$	set-point controller
	$CFnc = 1$	continuous controller (PID)
	$CRct = 0$	inverse action (e.g. heating applications)
$CONF / OUT.3:$	$OUTP = 1/2$	$O_{ut.3}$ type ( $0/4 \dots 20\text{mA}$ )
	$OUT0 = -1999\dots9999$	scaling analog output $0/4\text{mA}$
	$OUT1 = -1999\dots9999$	scaling analog output $20\text{mA}$
$PRrR / ENTR:$	$Pb1 = 0,1\dots9999$	proportional band 1 (heating) in units of phys. quantity (e.g. $^{\circ}\text{C}$ )
	$t_i1 = 1\dots9999$	integral time 1 (heating) in sec.
	$t_d1 = 1\dots9999$	derivative time 1 (heating) in sec.
	$t1 = 0,4\dots9999$	min. cycle time 1 (heating)
$PRrR / SEtP:$	$SP.L0 = -1999\dots9999$	set-point limit low for Weff
	$SP.H0 = -1999\dots9999$	set-point limit high for Weff

- i** For direct action of the continuous controller, the controller action must be changed ( $CONF / ENTR / CRct = 1$ ).
- i** To prevent control outputs  $O_{ut.1}$  and  $O_{ut.2}$  of the continuous controller from switching simultaneously, the control function of outputs  $O_{ut.1}$  and  $O_{ut.2}$  must be switched off ( $CONF / O_{ut.1}$  and  $O_{ut.2} / Y.1$  and  $Y.2 = 0$ ).

4.4.6  $\Delta Z$  Y - Off controller / 2-point controller with pre-contact

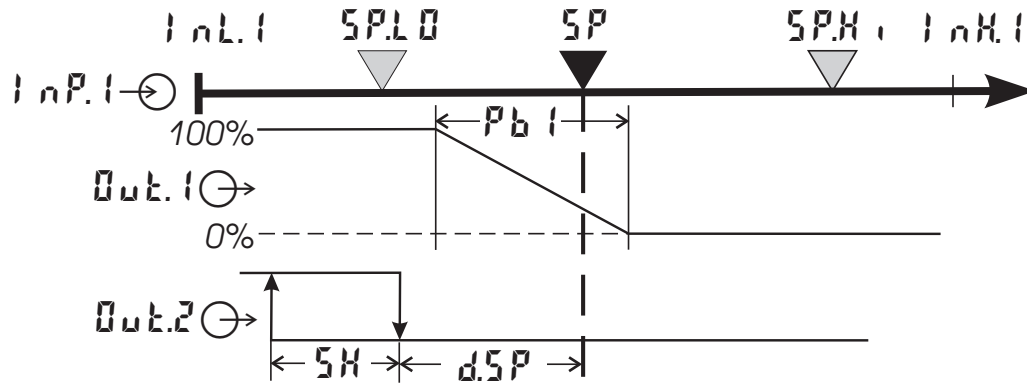

CONF / Contr:	SPFn = 0	set-point controller
	CFnc = 2	$\Delta$ -Y-Off controller
	CAct = 0	inverse action (e.g. heating applications)
CONF / Out.1:	OAct = 0	action Out.1 direct
	Y.1 = 1	control output Y1 active
	Y.2 = 0	control output Y2 not active
CONF / Out.2:	OAct = 0	action Out.2 direct
	Y.1 = 0	control output Y1 not active
	Y.2 = 1	control output Y2 active
PRrA / Contr:	Pb.1 = 0,1...9999	proportional band 1 (heating) in units of phys. quantity (e.g. °C)
	t.i.1 = 1...9999	integral time 1 (heating) in sec.
	t.d.1 = 1...9999	derivative time 1 (heating) in sec.
	t.1 = 0,4...9999	min. cycle time 1 (heating)
	SH = 0...9999	switching difference
	d.SP = -1999...9999	trigg. point separation suppl. cont. $\Delta$ / Y / Off in units of phys. quanti-
ty PRrA / SEtP:	SP.L0 =	
-1999...9999		set-point limit low for Weff
	SP.H.1 = -1999...9999	set-point limit high for Weff

## 4.4.7 KS4x-1 with measured value output

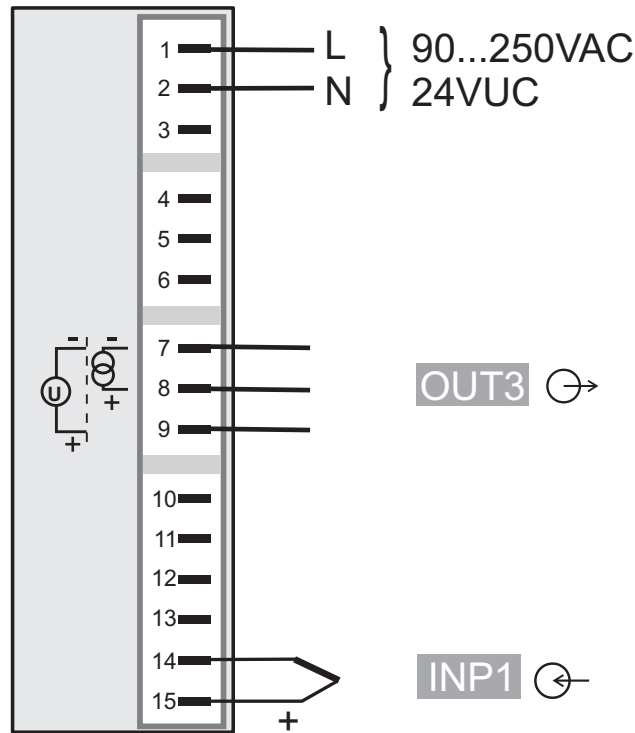
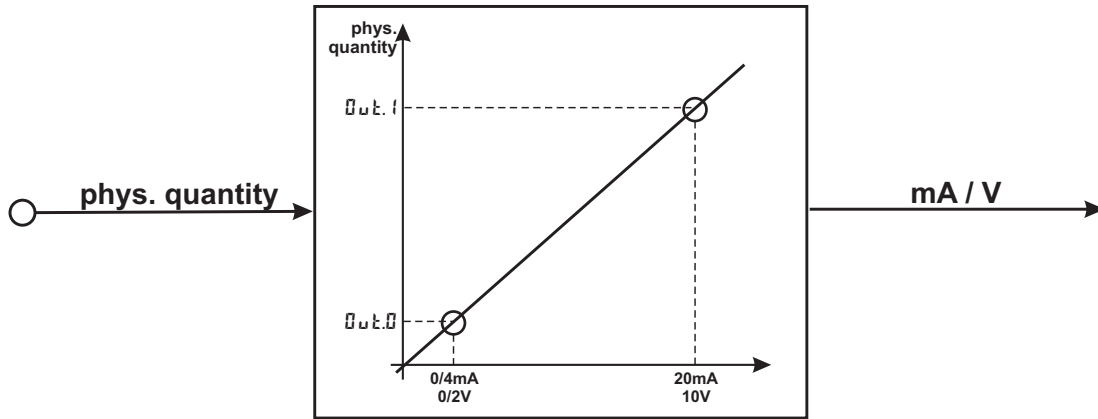

<code>Conf / Out.3:</code>	<code>Out.P</code>	<code>= 1</code>	<code>Out.3</code>	0...20mA continuous
		<code>= 2</code>	<code>Out.3</code>	4...20mA continuous
		<code>= 3</code>	<code>Out.3</code>	0...10V continuous
		<code>= 4</code>	<code>Out.3</code>	2...10V continuous
	<code>Out.0</code>	<code>= -1999...9999</code>	scaling <code>Out.3</code>	
			for 0/4mA or 0/2V	
	<code>Out.1</code>	<code>= -1999...9999</code>	scaling <code>Out.3</code>	
			for 20mA or 10V	
	<code>Out.c</code>	<code>= 3</code>	signal source for <code>Out.3</code>	is the process value

**5** Parameter setting level

**5.1** *Parameter survey*

PARAM Parameter setting level							
	Ctrl Control and self-tuning	SETP Set-point and process value	Prog Programmer	Input 1	Input 2	Limit value functions	End
▲	Pb1	SPLo	SP.01	InL1	InL2	L.1	
▼	Pb2	SP.H1	Pt.01	OutL1	OutL2	H.1	
	t.1	SP.2	SP.02	InH1	InH2	HYS.1	
	t.2	r.SP	Pt.02	OutH1	OutH2	L.2	
	td1	t.SP	SP.03	t.F.1		H.2	
	td2		Pt.03			HYS.2	
	t1		SP.04			dEL.2	
	t2		Pt.04			L.3	
	SH					H.3	
	dSP					HYS.3	
	tP					HCR	
	tt						
	y2						
	yLo						
	yH1						
	y0						
	yH						
	LYH						

**Adjustment:**

- The parameters can be adjusted by means of keys ▲▼
- Transition to the next parameter is by pressing key →
- After the last parameter of a group, done is displayed, followed by automatic change to the next group.

**i** Return to the beginning of a group is by pressing the ← key for 3 sec.

**i** If for 30 sec. no keypress is executed the controller returns to the process value and setpoint display ( Time Out = 30 sec. )

## 5.2 Parameters

### Contr

Name	Value range	Description	Default
Pb1	1...9999 ①	Proportional band 1/2 (heating) in phys. dimensions (e.g. °C)	100
Pb2	1...9999 ①	Proportional band 2 (cooling) in phys. dimensions (e.g. °C)	100
t1	1...9999	Integral action time 1 (heating) [s]	180
t2	1...9999	Integral action time 2 (cooling) [s]	180
td1	1...9999	Derivative action time 1 (heating) [s]	180
td2	1...9999	Derivative action time 2 (cooling) [s]	180
t1 t2	0,4...9999	Minimal cycle duration 1/2 (heating/cooling) [s]. The minimum impulse is 1/4 x t1/t2	10
SH	0...9999	Dead zone or switching differential for on-off control [phys. dimensions]	2
dSP	-1999...9999	Trigger point separation for series contact Δ / Y / Off [phys. dimensions]	100
tP	0,1...9999	Minimum impulse [s]	OFF
tE	3...9999	Actuator response time for servo-motor [s]	60
Y2	-120...120	2. correcting variable	0
YL0	-120...120	Lower output limit [%]	0
YH1	-120...120	Upper output limit [%]	100
Y0	-120...120	Working point for the correcting variable [%]	0
Ym	-120...120	Limitation of the mean value Ym [%]	5
LYm	0...9999	Max. deviation xw at the start of mean value calculation [phys. dimensions]	8

① Valid for Conf / other / dP = 0. At dP = 1/2/3 also 0,1 / 0,01 / 0,001.

### SELP

Name	Value range	Description	Default
SPLO	-1999...9999	Set-point limit low for Weff	0
SPH1	-1999...9999	Set-point limit high for Weff	900
SP2	-1999...9999	Set-point 2.	0
r.SP	0...9999	Set-point gradient [/min]	OFF
t.SP	0...9999	Timer time [min]	5
SP	-1999...9999	Set-point (only visible with BlueControl!)	0

### Prog

Name	Value range	Description	Default
SP01	-1999...9999	Segment end set-point 1	100 ①
PE01	0...9999	Segment time 1 [min]	10 ②
SP02	-1999...9999	Segment end set-point 2	100 ①
PE02	0...9999	Segment time 2 [min]	10 ②
SP03	-1999...9999	Segment end set-point 3	200 ①
PE03	0...9999	Segment time 3 [min]	10 ②

Name	Value range	Description	Default
SP.04	-1999...9999	Segment end set-point 4	200 ①
PE.04	0...9999	Segment time 4 [min]	10 ②

① If SP.01 ... SP.04 = OFF then following parameters are not shown

② If segment end set-point = OFF then the segment time is not visible

## 1 nP.1

Name	Value range	Description	Default
InL.1	-1999...9999	Input value for the lower scaling point	0
ObL.1	-1999...9999	Displayed value for the lower scaling point	0
InH.1	-1999...9999	Input value for the upper scaling point	20
ObH.1	-1999...9999	Displayed value for the lower scaling point	20
TF1	-1999...9999	Filter time constant [s]	0,5

## 1 nP.2

Name	Value range	Description	Default
InL.2	-1999...9999	Input value for the lower scaling point	0
ObL.2	-1999...9999	Displayed value for the lower scaling point	0
InH.2	-1999...9999	Input value for the upper scaling point	50
ObH.2	-1999...9999	Displayed value for the upper scaling point	50

## L nA

Name	Value range	Description	Default
L.1	-1999...9999	Lower limit 1	-10
H.1	-1999...9999	Upper limit 1	10
HYS.1	0...9999	Hysteresis limit 1	1
L.2	-1999...9999	Lower limit 2	OFF
H.2	-1999...9999	Upper limit 2	OFF
HYS.2	0...9999	Hysteresis limit 2	1
L.3	-1999...9999	Lower limit 3	OFF
H.3	-1999...9999	Upper limit 3	OFF
HYS.3	0...9999	Hysteresis limit 3	1
HCR	-1999...9999	Heat current control limit [A]	50



Resetting the controller configuration to factory setting (Default)  
→ chapter 12.1 (page 56)

## 5.3 Input scaling

When using current or voltage signals as input variables for  $I_{nP.1}$  or  $I_{nP.2}$ , scaling of input and display values at parameter setting level is required. Specification of the input value for lower and higher scaling point is in the relevant electrical unit (mA / V).

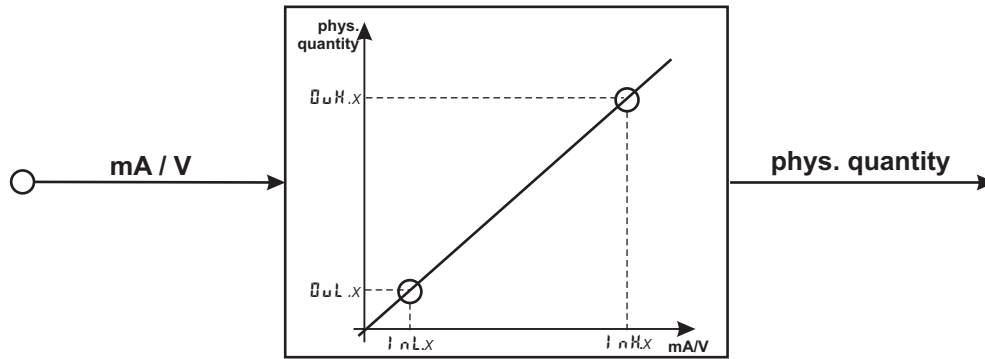

### 5.3.1 Input $I_{nP.1}$

**i** Parameters  $I_{nL.1}$ ,  $Q_{uL.1}$ ,  $I_{nH.1}$  and  $Q_{uH.1}$  are only visible if  $CONF / I_{nP.1} / CORR = 3$  is chosen.

SEYP	Input signal	$I_{nL.1}$	$Q_{uL.1}$	$I_{nH.1}$	$Q_{uH.1}$
30 (0...20mA)	0 ... 20 mA	0	any	20	any
	4 ... 20 mA	4	any	20	any
40 (0...10V)	0 ... 10 V	0	any	10	any
	2 ... 10 V	2	any	10	any

In addition to these settings,  $I_{nL.1}$  and  $I_{nH.1}$  can be adjusted in the range (0...20mA / 0...10V) determined by selection of SEYP.

**!** For using the predetermined scaling with thermocouple and resistance thermometer (Pt100), the settings for  $I_{nL.1}$  and  $Q_{uL.1}$  and for  $I_{nH.1}$  and  $Q_{uH.1}$  must have the same value.

**i** Input scaling changes at calibration level (→ page 41) are displayed by input scaling at parameter setting level. After calibration reset (OFF), the scaling parameters are reset to default.

### 5.3.2 Input $I_{nP.2}$

SEYP	Input signal	$I_{nL.2}$	$Q_{uL.2}$	$I_{nH.2}$	$Q_{uH.2}$
30	0 ... 20 mA	0	any	20	any
31	0 ... 50 mA	0	any	50	any

In addition to these settings,  $I_{nL.2}$  and  $I_{nH.2}$  can be adjusted in the range (0...20/ 50mA) determined by selection of SEYP.



**6 Calibration level**

**i** Measured value correction ( $\text{CAL}$ ) is only visible if  $\text{CONF} / \text{INP.1} / \text{CORR} = 1$  or  $2$  is chosen.

The measured value can be matched in the calibration menu ( $\text{CAL}$ ). Two methods are available:

**Offset correction**

( $\text{CONF} / \text{INP.1} / \text{CORR} = 1$ ):

- possible on-line at the process

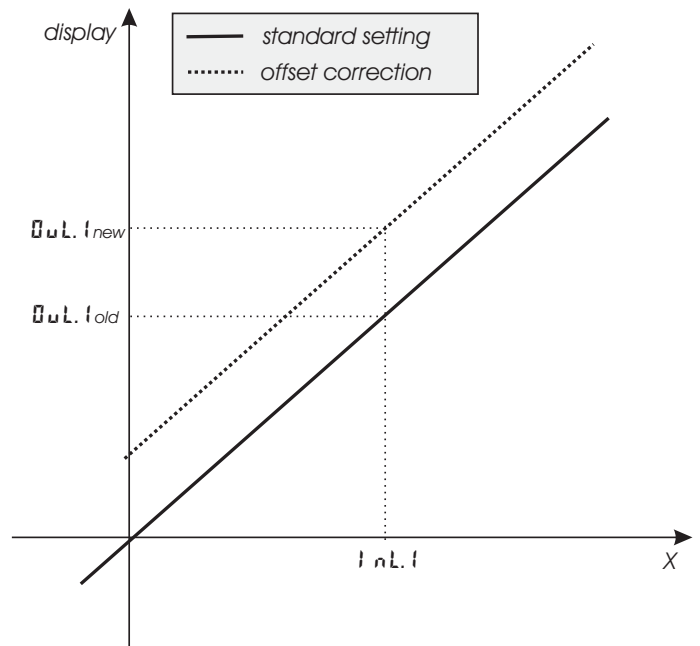

**2-point correction**

( $\text{CONF} / \text{INP.1} / \text{CORR} = 2$ ):

- is possible off-line with process value simulator

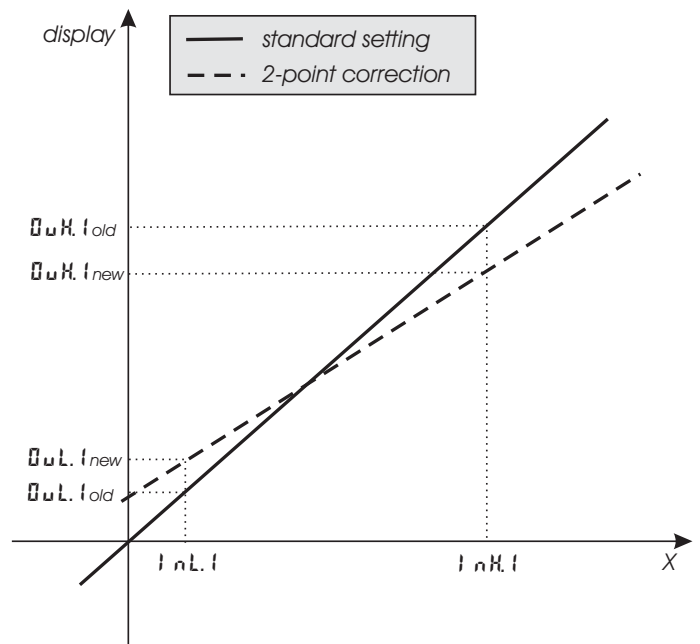

*Offset correction (CONF / InP.1 / Corr = 1):*

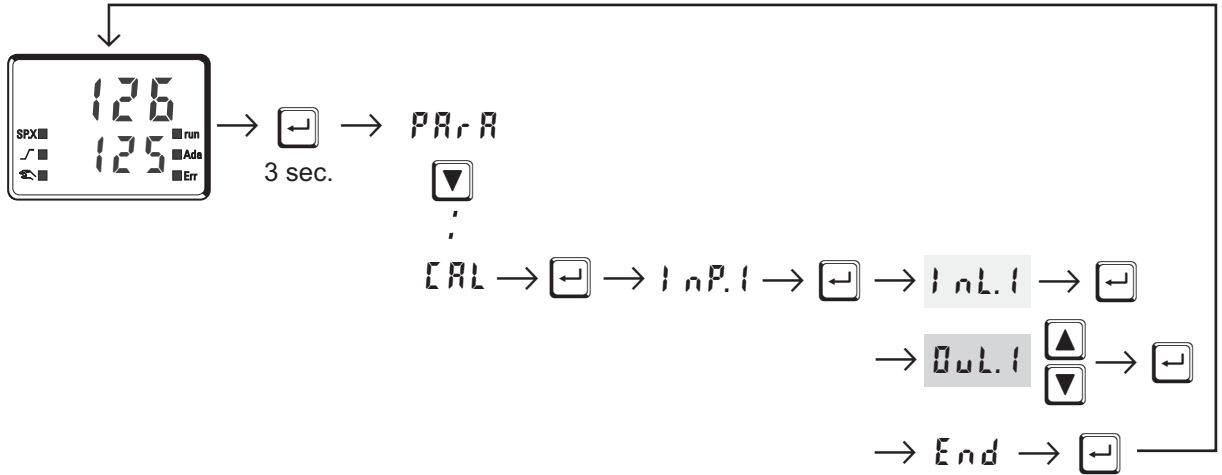

- InL.1:** The input value of the scaling point is displayed.  
The operator must wait, until the process is at rest.  
Subsequently, the operator acknowledges the input value by pressing key .
- Out.1:** The display value of the scaling point is displayed.  
Before calibration, **Out.1** is equal to **InL.1**.  
The operator can correct the display value by pressing keys .  
Subsequently, he confirms the display value by pressing key .

2-point correction (CONF / INP.1 / CORR = 1):

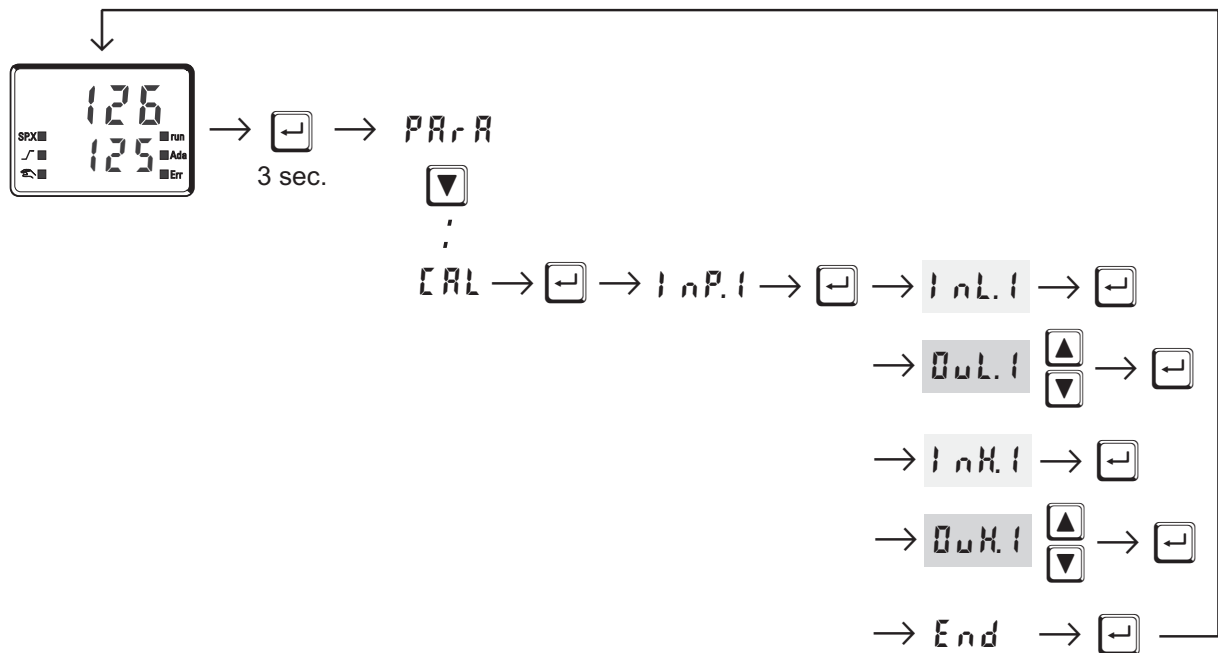

- INL.1:** The input value of the lower scaling point is displayed.  
The operator must adjust the lower input value by means of a process value simulator and confirm the input value by pressing key
- OUT.1:** The display value of the lower scaling point is displayed.  
Before calibration, **OUT.1** equals **INL.1**.  
The operator can correct the lower display value by pressing the keys. Subsequently, he confirms the display value by pressing key .
- INH.1:** The input value of the upper scaling point is displayed. .  
The operator must adjust the upper input value by means of the process value simulator and confirm the input value by pressing key .
- OUT.H.1:** The display value of the upper scaling point is displayed.  
Before calibration **OUT.H.1** equals **INH.1**.  
The operator can correct the upper display value by pressing keys Subsequently, he confirms the display value by pressing key .

The parameters (**OUT.1**, **OUT.H.1**) changed at **CAL** level can be reset by adjusting the parameters below the lowest adjustment value (**OFF**) by means of decrement key .

## 7 Programmer

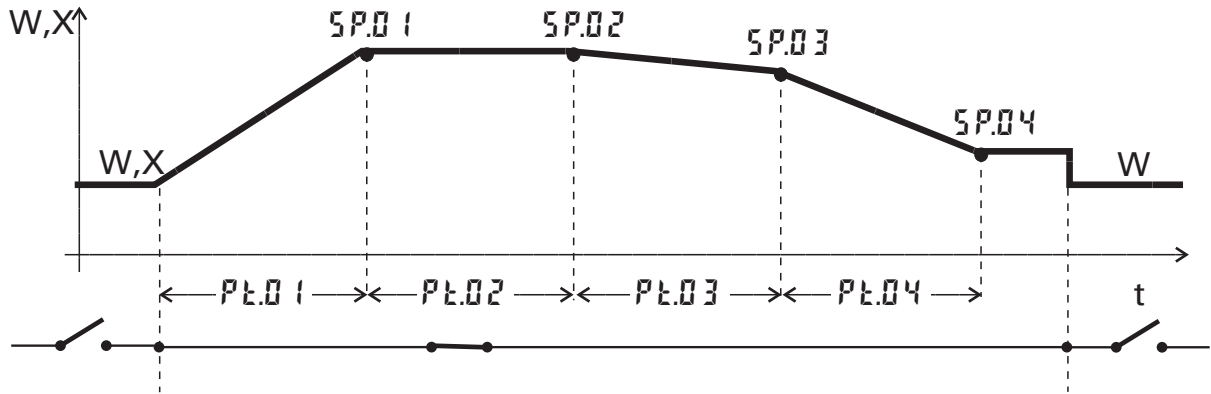

### Programmer set-up:

For using the controller as a programmer, select parameter  $SP.Fn = 1$  in the **CONF** menu (→ page 21). The programmer is started via one of digital inputs di1..3. Which input shall be used for starting the programmer is determined by selecting parameter  $P.run = 2 / 3 / 4$  in the **CONF** menu accordingly. (→ page 23).

For assigning the program end as a digital signal to one of the relay outputs, parameter  $P.End = 1$  must be selected for the relevant output  $OUT.1 \dots OUT.3$  in the **CONF** menu (→ page 26, 27).

### Programmer parameter setting:

A programmer with 4 segments is available to the user. Determine a segment duration  $PL.01 \dots PL.04$  (in minutes) and a segment target set-point  $SP.01 \dots SP.04$  for each segment in the **PRP** menu (→ page 38).

### Starting/stopping the programmer:

Starting the programmer is done by a digital signal at input di1..3 selected by parameter  $P.run$  (→ page 23).

The programmer calculates a gradient from segment end setpoint and segment time. This gradient is always valid. Normally, the programmer starts the first segment at process value. Because of this the effective run-time of the first segment may differ from the at **PRP** level setted segment time (process value  $\neq$  setpoint).

After program end, the controller continues controlling with the target set-point set last.

If the program is stopped during execution (signal at digital input di1..3 is taken away), the programmer returns to program start and waits for a new start signal.



**Program parameter changing while the program is running is possible.**

***Changing the segment time:***

Changing the segment time leads to re-calculation of the required gradient. When the segment time has already elapsed, starting with the new segment is done directly, where the set-point changes with a step.

***Changing the segment end setpoint:***

Changing the set-point leads to re-calculation of the required gradient, in order to reach the new set-point during the segment rest time, whereby the required gradient polarity sign can change.

**8** Timer

**8.1** *Setting up the timer*

**8.1.1** Operating modes

6 different timer modes are available to the user. The relevant timer mode can be set via parameter  $SPFn$  in the  $CONF$  menu ( $\rightarrow$  page 21).

**Mode 1 (—)**

After timer start, control is to the adjusted set-point. The timer ( $t.SP$ ) runs as soon as the process value enters or leaves the band around the set-point ( $x = SP \pm b.t$ ). After timer elapse, the controller returns to  $YZ$ . **End** and the set-point are displayed alternately in the lower display line.

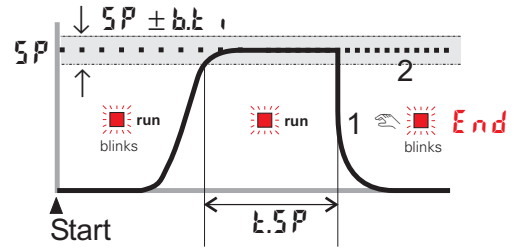

**Mode 2 (⋯)**

Mode 2 corresponds to mode 1, except that control is continued with the relevant set-point after timer ( $t.SP$ ) elapse.

**Mode 3 (—)**

After timer start, control is to the adjusted set-point. The timer ( $t.SP$ ) starts immediately after switch-over. After timer elapsing the controller switches off. **End** and the set-point are displayed alternately in the bottom display line.

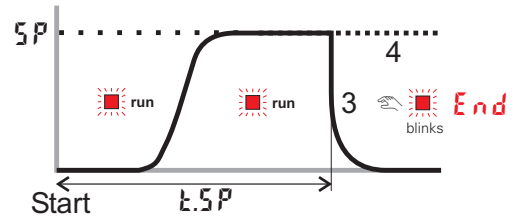

**Mode 4 (⋯)**

Mode 4 corresponds to mode 3, except that control is continued with the relevant set-point after timer ( $t.SP$ ) elapse.

**Mode 5 (delay)**

The timer starts immediately. The controller output remains on  $YZ$ . After timer ( $t.SP$ ) elapse, control starts with the adjusted set-point.

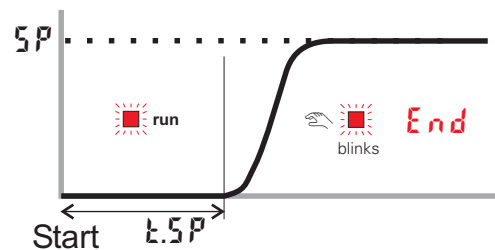

**Mode 6**

After set-point switch-over ( $SP \rightarrow SP.2$ ), control is to  $SP.2$ . The timer ( $t.SP$ ) starts when the process value enters the adjusted band around the set-point ( $x = SP.2 \pm b.t$ ). After time elapse the controller returns to  $SP$ . **End** and the set-point are displayed alternately in the lower display line.

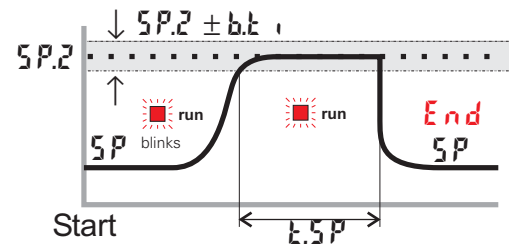

**8.1.2 Tolerance band**

Timer modes 1,2 and 6 are provided with a freely adjustable tolerance band. The tolerance band around the set-point can be adjusted via parameter  $b.t$  in the **CONF** menu ( $x = SP.2 \pm b.t$ ) (→ page 21).

**8.1.3 Timer start**

Various procedures for starting the timer are possible:

Start via	LOG1		Mode						
	Y2 =	SP.2 =	1	2	3	4	5	6	
Y / Y2 switch-over via digital input <sup>①</sup>	di1	2	x	✓	✓	✓	✓	✓	-
	di2	3	x	✓	✓	✓	✓	✓	-
	di3	4	x	✓	✓	✓	✓	✓	-
SP / SP.2 switch-over via digital input <sup>①</sup>	di1	x	2	-	-	-	-	-	✓
	di2	x	3	-	-	-	-	-	✓
	di3	x	4	-	-	-	-	-	✓
Pressing key	6	x	✓	✓	✓	✓	✓	✓	-
Power On	0	x	✓	✓	✓	✓	✓	✓	-
	x	0	-	-	-	-	-	-	✓
Changing $b.t$ (extended operating level)	x	x	✓	✓	✓	✓	✓	✓	✓
Serial interface (if provided)	x	x	✓	✓	✓	✓	✓	✓	✓

<sup>①</sup> when using a digital input, adjust parameter  $d.F.n = 2$  (**CONF/LOG1**) (key function)  
 x no effect

## 8.1.4 Signal end

If one of the relays shall switch after timer elapse, parameter  $EN = 1$  and inverse action  $ACT = 1$  must be selected for the relevant output  $OUT.1 \dots OUT.3$  in the  $CONF$  menu ( $\rightarrow$  page 25, 26). If direct action is selected, the relevant output signals the active timer.

## 8.2 Determining the timer run-time

The timer run-time can be determined via parameter  $ESP$  in the  $PARAM$  menu. The timer run-time must be specified in minutes with one digit behind the decimal point (0,1 minutes = 6 seconds).

Alternatively, the timer run-time can be determined directly at extended operating level ( $\rightarrow$  chapter 8.3).

## 8.3 Starting the timer

Dependent of configuration, the timer start is as follows:

- by a positive flank at one of digital inputs di1..3
- by pressing key 
- by switching on the controller (power On)
- by changing the timer run-time  $ESP > 0$  (extended operating level)
- via the serial interface

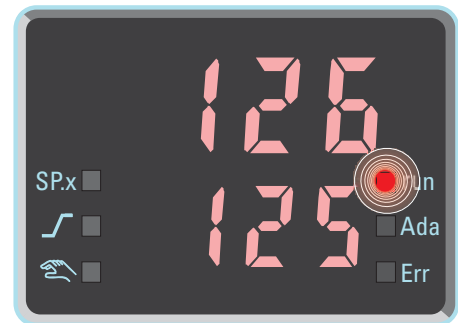

### Display:

Run LED	Signification
<b>blinks</b>	- timer was started - timer is not running yet
<b>lit</b>	- timer was started - timer is running
<b>off</b> ( $Err$ and setpoint are displayed alternately)	- timer is off - timer has elapsed - deletion of $Err$ display by pressing any key



With active timer, the time can be adjusted by changing parameter  $ESP$  at extended operating level.



## 9 BlueControl

BlueControl is the projection environment for the BluePort<sup>®</sup> controller series of PMA. The following 3 versions with graded functionality are available:

FUNCTIONALITY	MINI	BASIC	EXPERT
parameter and configuration setting	yes	yes	yes
controller and loop simulation	yes	yes	yes
download: transfer of an engineering to the controller	yes	yes	yes
online mode/ visualization	SIM only	yes	yes
defining an application specific linearization	yes	yes	yes
configuration in the extended operating level	yes	yes	yes
upload: reading an engineering from the controller	SIM only	yes	yes
basic diagnostic functions	no	no	yes
saving data file and engineering	no	yes	yes
printer function	no	yes	yes
online documentation, help	yes	yes	yes
implementation of measurement value correction	yes	yes	yes
data acquisition and trend display	SIM only	yes	yes
wizard function	yes	yes	yes
extended simulation	no	no	yes
programmeditor (KS 90-1prog only)	no	no	yes

The mini version is - free of charge - at your disposal as download at PMA home-page [www.pma-online.de](http://www.pma-online.de) or on the PMA-CD (please ask for).

At the end of the installation the licence number has to be stated or DEMO mode must be chosen.

At DEMO mode the licence number can be stated subsequently under **Help** → **Licence** → **Change**.

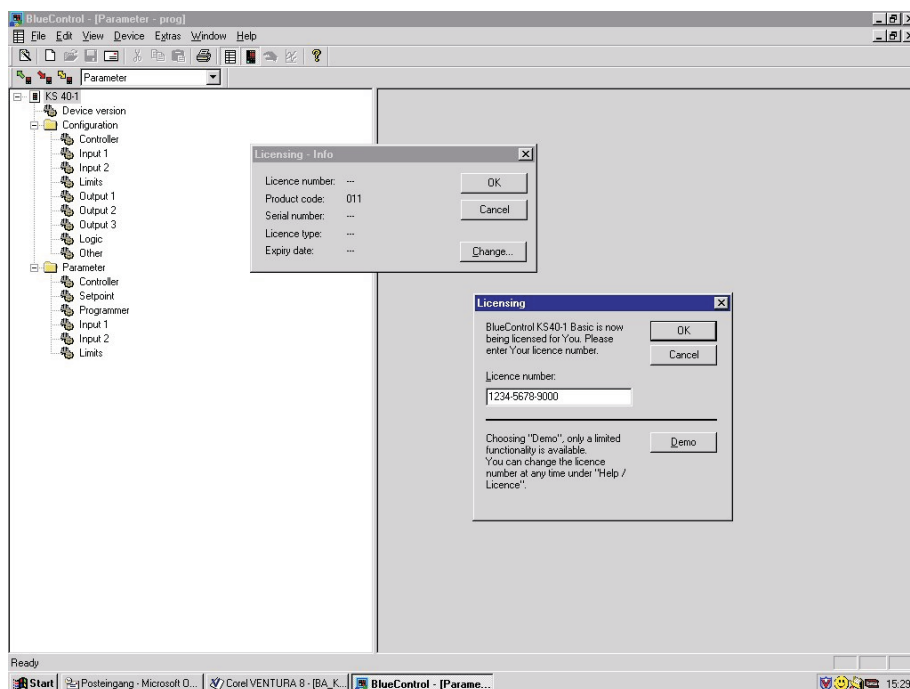

## 10 Versions

	K	S	4	-	1	-	0	0	-	00
KS 40-1 (1/8 DIN)	0									
KS 41-1 (1/8 DIN "landscape")	1									
KS 42-1 (1/4 DIN)	2									
Flat-pin connectors					0					
Screw terminals					1					
90..250V AC, 3 relays						0				
24VAC / 18..30VDC, 3 relays						1				
90..250V AC, 2 relays + mA/logic						2				
24VAC / 18..30VDC, 2 relays +mA/logic						3				
no option							0			
RS422/485 + Transmitter power supply +di2, di3							1			
Standard configuration								0		
Configuration to specification								9		
no manual									0	
manual german									D	
manual english									E	
manual french									F	
Standard (CE certified)										0
cULus-certified (with screw terminals only)										U
DIN 3440 certified										D
German Lloyd certified										G

### Accessories delivered with the unit

Operating manual (if selected by the ordering code)

- 2 fixing clamps
- operating note in 15 languages

### Accessory equipment with ordering information

Description			Order no.
Heating current transformer 50A AC			9404-407-50001
PC-adaptor for the front-panel interface			9407-998-00001
Standard rail adaptor			9407-998-00061
Operating manual	German		9499-040-62718
Operating manual	English		9499-040-62711
Operating manual	French		9499-040-62732
Interface description Modbus RTU	German		9499-040-63518
Interface description Modbus RTU	English		9499-040-63511
BlueControl (engineering tool)	Mini	Download	www.pma-online.de
BlueControl (engineering tool)	Basic		9407-999-11001
BlueControl (engineering tool)	Expert		9407-999-11011

## 11 Technical data

### INPUTS

#### PROCESS VALUE INPUT INP1

Resolution: > 14 bits  
 Decimal point: 0 to 3 digits behind the decimal point  
 Dig. input filter: adjustable 0,000...9999 s  
 Scanning cycle: 100 ms  
 Measured value correction: 2-point or offset correction

#### Thermocouples

→ Table 1 (page 53)

Input resistance:  $\geq 1 \text{ M}\Omega$   
 Effect of source resistance:  $1 \mu\text{V}/\Omega$

#### Cold-junction compensation

Maximal additional error:  $\pm 0,5 \text{ K}$

#### Sensor break monitoring

Sensor current:  $\leq 1 \text{ mA}$   
 Configurable output action

#### Resistance thermometer

→ Table 2 (page 53)

Connection: 2 or 3-wire  
 Lead resistance: max. 30 Ohm  
 Input circuit monitor: break and short circuit

#### Special measuring range

BlueControl (engineering tool) can be used to match the input to sensor KTY 11-6 (characteristic is stored in the controller).

Physical measuring range: 0...4500 Ohm  
 Linearization segments: 16

#### Current and voltage signals

→ Table 3 (page 53)

Span start, end of span: anywhere within measuring range  
 Scaling: selectable -1999...9999  
 Linearization: 16 segments, adaptable with BlueControl  
 Decimal point: adjustable  
 Input circuit monitor: 12,5% below span start (2mA, 1V)

#### SUPPLEMENTARY INPUT INP2

Resolution: > 14 bits  
 Scanning cycle: 100 ms  
 Accuracy: < 0,5 %

#### Heating current measurement

via current transformer (→ Accessory equipment)

Measuring range: 0...50mA AC  
 Scaling: adjustable -1999...0,000...9999 A

#### Current measuring range

Technical data as for INP1

#### CONTROL INPUT DI1

Configurable as switch or push-button!  
 Connection of a potential-free contact suitable for switching "dry" circuits.

Switched voltage: 2,5 V  
 Current: 50  $\mu\text{A}$

#### CONTROL INPUTS DI2, DI3 (OPTION)

Configurable as switch or push-button!  
 Optocoupler input for active triggering

Nominal voltage: 24 V DC external  
 Current sink (IEC 1131 type 1)  
 Logic "0": -3...5 V  
 Logic "1": 15...30 V  
 Current requirement: approx.. 5 mA

#### TRANSMITTER SUPPLY $U_T$ (OPTION)

Power: 22 mA /  $\geq 18 \text{ V}$

If the universal output OUT3 is used there may be no external galvanic connection between measuring and output circuits!

#### GALVANIC ISOLATION

— Safety isolation  
 = Function isolation

Power supply connections	Process value input INP1 Supplementary input INP2 Digital input di1
Relay outputs OUT 1,2	RS422/485 interface
Relay output OUT3	Digital inputs di2, 3 Universal output OUT3 Transmitter supply $U_T$

### OUTPUTS

#### RELAY OUTPUTS OUT1, OUT2

Contact type: 2 NO contacts with common connection  
 Max. contact rating: 500 VA, 250 V, 2A at 48...62Hz, resistive load  
 Min. contact rating: 6V, 1 mA DC

## Technical data

Operating life (electr.): 800.000 duty cycles with max. rating

### **OUT3 USED AS RELAY OUTPUT**

Contact type: potential-free changeover contact  
Max.contact rating: 500 VA, 250 V, 2A at 48...62Hz, resistive load  
Min. contact rating: 5V, 10 mA AC/DC  
Operating life (electr.): 600.000 duty cycles with max. contact rating

#### **Note:**

If the relays OUT1...OUT3 operate external contactors, these must be fitted with RC snubber circuits to manufacturer specifications to prevent excessive switch-off voltage peaks.

### **OUT3 AS UNIVERSAL OUTPUT**

Galvanically isolated from the inputs.

Freely scalable  
Resolution: 11 bits

#### **Current output**

0/4...20 mA configurable.  
Signal range: 0...approx.22mA  
Max. load:  $\leq 500 \Omega$   
Load effect: no effect  
Resolution:  $\leq 22 \mu\text{A}$  (0,1%)  
Accuracy:  $\leq 40 \mu\text{A}$  (0,2%)

#### **Voltage output**

0/2...10V configurable  
Signal range: 0...11 V  
Min. load:  $\geq 2 \text{ k}\Omega$   
Load effect: no effect  
Resolution:  $\leq 11 \text{ mV}$  (0,1%)  
Accuracy:  $\leq 20 \text{ mV}$  (0,2%)

#### **OUT3 used as transmitter supply**

Output power: 22 mA /  $\geq 13 \text{ V}$

#### **OUT3 used as logic output**

Load  $\leq 500 \text{ W}$  0/ $\leq 20 \text{ mA}$   
Load  $> 500 \text{ W}$  0/ $> 13 \text{ V}$

## **POWER SUPPLY**

Dependent of order:

### **AC SUPPLY**

Voltage: 90...260 V AC  
Frequency: 48...62 Hz  
Power consumption approx. 7.0 VA

### **UNIVERSAL SUPPLY 24 V UC**

AC voltage: 20,4...26,4 V AC  
Frequency: 48...62 Hz  
DC voltage: 18...31 V DC class 2  
Power consumption: approx.. 7,0 VA

### **BEHAVIOUR WITH POWER FAILURE**

*Configuration, parameters and adjusted set-points, control mode:*

Non-volatile storage in EEPROM

### **BLUEPORT FRONT INTERFACE**

Connection of PC via PC adapter (see "Accessory equipment"). The BlueControl software is used to configure, set parameters and operate the KS4x-1.

### **BUS INTERFACE (OPTION)**

Galvanically isolated  
Physical: RS 422/485  
Protocol: Modbus RTU  
Transmission speed: 2400, 4800, 9600, 19.200 bits/sec  
Address range: 1...247  
Number of controllers per bus: 32  
Repeaters must be used to connect a higher number of controllers.

## **ENVIRONMENTAL CONDITIONS**

### **Protection modes**

Front panel: IP 65 (NEMA 4X)  
Housing: IP 20  
Terminals: IP 00

### **Permissible temperatures**

For specified accuracy: 0...60°C  
Warm-up time:  $\geq 15$  minutes  
For operation: -20...65°C  
For storage: -40...70°C

### **Humidity**

75% yearly average, no condensation

### **Shock and vibration**

#### **Vibration test Fc (DIN 68-2-6)**

Frequency: 10...150 Hz  
Unit in operation: 1g or 0,075 mm  
Unit not in operation: 2g or 0,15 mm

#### **Shock test Ea (DIN IEC 68-2-27)**

Shock: 15g  
Duration: 11ms

## Electromagnetic compatibility

Complies with EN 61 326-1  
(for continuous, non-attended operation)

- Thermal transfer plants with organic transfer media to **DIN 4754**
- Oil-heated plants to **DIN 4755**

## GENERAL

### Housing

Material: Makrolon 9415  
flame-retardant  
Flammability class: UL 94 V0, self-extinguishing  
Plug-in module, inserted from the front

### Safety test

Complies with EN 61010-1 (VDE 0411-1):  
Overvoltage category II  
Contamination class 2  
Working voltage range 300 V  
Protection class II

### cULus certification

(Type 1, indoor use)  
File: E 208286

### Mounting

Panel mounting with two fixing clamps at top/bottom or right/left,  
High-density mounting possible

Mounting position: uncritical  
Weight: 0,27kg

### Accessories delivered with the unit

Operating manual  
Fixing clamps

## Certifications

Type-tested to **DIN EN 14597** (replaces **DIN 3440**)

With the according sensors applicable for:

- Heat generating plants with outflow temperatures up to 120°C to **DIN 4751**
- Hot water plants with outflow temperatures above 110°C to **DIN 4752**

Table 1 Thermocouple measuring ranges

Thermocouple type	Range	Accuracy	Resolution (∅)
L Fe-CuNi (DIN)	-100...900°C -148...1652°F	≤ 2K	0,1 K
J Fe-CuNi	-100...1200°C -148...2192°F	≤ 2K	0,1 K
K NiCr-Ni	-100...1350°C -148...2462°F	≤ 2K	0,2 K
N Nicrosil/Nisil	-100...1300°C -148...2372°F	≤ 2K	0,2 K
S PtRh-Pt 10%	0...1760°C 32...3200°F	≤ 2K	0,2 K
R PtRh-Pt 13%	0...1760°C 32...3200°F	≤ 2K	0,2 K

Table 2 Resistance transducer measuring ranges

Type	Sens. current	Range	Accuracy	Resolution (∅)
Pt100	0,2mA	-200...100°C -140...212°F	≤ 1K	0,1K
Pt100		-200...850°C -140...1562°F	≤ 1K	0,1K
Pt1000		-200...850°C -140...1562°F	≤ 2K	0,1K
KTY 11-6		-50...150°C -58...302°F	≤ 2K	0,05K

Table 3 Current and voltage measuring ranges

Range	Input resistance	Accuracy	Resolution (∅)
0-10 Volt	≈ 110 kΩ	≤ 0,1 %	≤ 0,6 mV
0-20 mA	49 Ω (voltage requirement ≤ 2,5 V)	≤ 0,1 %	≤ 1,5 μA

### 12 Safety hints

This unit was built and tested in compliance with VDE 0411-1 / EN 61010-1 and was delivered in safe condition.

The unit complies with European guideline 89/336/EEG (EMC) and is provided with CE marking.

The unit was tested before delivery and has passed the tests required by the test schedule. To maintain this condition and to ensure safe operation, the user must follow the hints and warnings given in this operating manual.

The unit is intended exclusively for use as a measurement and control instrument in technical installations.



#### **Warning**

If the unit is damaged to an extent that safe operation seems impossible, the unit must not be taken into operation.

#### **ELECTRICAL CONNECTIONS**

The electrical wiring must conform to local standards (e.g. VDE 0100). The input measurement and control leads must be kept separate from signal and power supply leads.

In the installation of the controller a switch or a circuit-breaker must be used and signified. The switch or circuit-breaker must be installed near by the controller and the user must have easy access to the controller.

#### **COMMISSIONING**

Before instrument switch-on, check that the following information is taken into account:

- Ensure that the supply voltage corresponds to the specifications on the type label.
- All covers required for contact protection must be fitted.
- If the controller is connected with other units in the same signal loop, check that the equipment in the output circuit is not affected before switch-on. If necessary, suitable protective measures must be taken.
- The unit may be operated only in installed condition.
- Before and during operation, the temperature restrictions specified for controller operation must be met.

#### **SHUT-DOWN**

For taking the unit out of operation, disconnect it from all voltage sources and protect it against accidental operation.

If the controller is connected with other equipment in the same signal loop, check that other equipment in the output circuit is not affected before switch-off. If necessary, suitable protective measures must be taken.

**MAINTENANCE, REPAIR AND MODIFICATION**

The units do not need particular maintenance.

**Warning**

When opening the units, or when removing covers or components, live parts and terminals may be exposed.

**Before starting this work, the unit must be disconnected completely.**

After completing this work, re-shut the unit and re-fit all covers and components. Check if specifications on the type label must be changed and correct them, if necessary.

**Caution**

When opening the units, components which are sensitive to electrostatic discharge (ESD) can be exposed. The following work may be done only at workstations with suitable ESD protection.

Modification, maintenance and repair work may be done only by trained and authorized personnel. For this purpose, the PMA service should be contacted.



The cleaning of the front of the controller should be done with a dry or a wetted (spirit, water) kerchief.

## 12.1 *Resetting to factory setting*

In case of faulty configuration, KS4x-1 can be reset to the default condition.



- ➊ For this, the operator must keep the keys increment and decrement pressed during power-on.
- ➋ Then, press key increment to select **YES**.
- ➌ Confirm factory resetting with Enter and the copy procedure is started (display **COPY**).
- ➍ Afterwards the device restarts.  
In all other cases, no reset will occur (timeout abortion).

- ⓘ If one of the operating levels was blocked and the safety lock is open, reset to factory setting is not possible.
- ⓘ If a pass number was defined (via BlueControl<sup>®</sup>) and the safety lock is open, but no operating level was blocked, enter the correct pass number when prompted in **➋**. A wrong pass number aborts the reset action.
- ⓘ The copy procedure ( **COPY** ) can take some seconds.  
Now, the transmitter is in normal operation.



## Index

### 0-9

2-point correction. . . . . 41

### A

Alarm handling . . . . . 18 - 19

### B

BlueControl. . . . . 49

Bus interface

    Technical Data. . . . . 52

### C

Calibration level (CAL) . . . . . 41 - 43

Certifications . . . . . 53

Configuration examples

    2-point controller . . . . . 31

    3-point controller . . . . . 32

    3-point stepping controller . . . . . 33

    Continuous controller . . . . . 34

    D - Y -Off controller. . . . . 35

    Measured value output . . . . . 36

    Signaller . . . . . 30

Configuration level

    Configuration parameters. . . . . 22 - 28

    Parameter survey . . . . . 21

Connecting diagram . . . . . 6

Connecting examples

    di2/3, 2-wire transmitter supply . . . . . 8

    INP2 current transformer . . . . . 7

    OUT1/2 heating/cooling . . . . . 7

    OUT3 as logic output . . . . . 8

    OUT3 transmitter supply . . . . . 8

    RS485 interface . . . . . 9

Control inputs di1, di2, di3

    Technical data . . . . . 51

Current signal measuring range . . . . . 51

### D

Digital inputs di1, di2, di3

    Configuration . . . . . 26

    Technical data . . . . . 51

### E

Environmental conditions . . . . . 53

Equipment . . . . . 50

Error list . . . . . 12

### F

Front view . . . . . 10

### I

Input INP1

    Configuration . . . . . 23

    Parameters . . . . . 39

    Technical data . . . . . 51

Input INP2

    Configuration . . . . . 23

    Parameters . . . . . 39

    Technical data . . . . . 51

Input scaling . . . . . 40

### K

Kalibrierung (CAL) . . . . . 41

### L

LED

    Ada - LED . . . . . 10

    Err - LED . . . . . 10

    ↘ - LED . . . . . 10

    LED colours . . . . . 10

    ☞ - LED. . . . . 10

    run - LED . . . . . 10

    SP.x - LED. . . . . 10

### M

Maintenance manager . . . . . 12 - 13

Manual tuning . . . . . 17

Mounting. . . . . 5

### O

Offset correction . . . . . 41

Output OUT1

    Configuration . . . . . 24

    Technical data . . . . . 52

Output OUT2

    Configuration . . . . . 25

    Technical data . . . . . 52

Output OUT3

    Configuration . . . . . 25

    Technical data . . . . . 52

### P

Parameter setting level

    Parameter survey . . . . . 37

    Parameters . . . . . 38 - 39

Power supply . . . . .	52
Programmer	
Changing segment end setpoint . . . . .	45
Changing segment time . . . . .	45
Parameter setting . . . . .	44
Set-up . . . . .	44
Starting/Stopping . . . . .	44

**R**

Resetting to factory setting . . . . .	56
Resistance thermometer measuring range . . . . .	51

**S**

Safety hints . . . . .	55 - 56
Safety switch. . . . .	5
Safety test. . . . .	53
Self-tuning	
Cancelation . . . . .	15
Cancelation causes. . . . .	16
Start . . . . .	15
Set-point processing . . . . .	29

**T**

Thermocouple measuring range . . . . .	51
Timer	
Display run-LED . . . . .	48
Operating modes. . . . .	46
Signal end . . . . .	48
Timer start . . . . .	47
Tolerance band . . . . .	47

**V**

Versions . . . . .	50
Voltage signal measuring range . . . . .	51



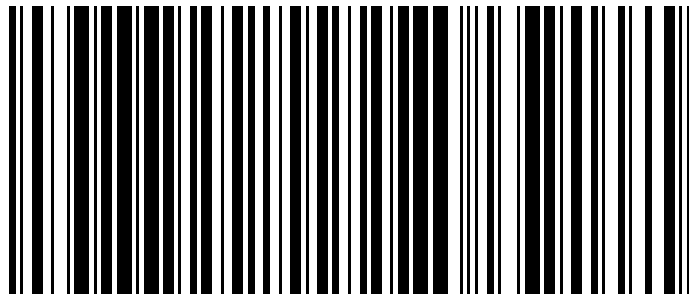

9499-040-62711

A5 auf A6 gefaltet, 2-fach geheftet, SW-Druck Normalpapier weiß 80g/m<sup>2</sup>

Subject to alterations without notice  
Änderungen vorbehalten  
Sous réserve de toutes modifications

© PMA Prozeß- und Maschinen-Automation GmbH  
P.O.B. 310 229, D-34058 Kassel, Germany  
Printed in Germany 9499-040-62711 (07/2011)

A6