

## PP20S industrial

Pressure sensor with ceramic cell and industrial connection

PP20S-1.####R.####.####00.004

### Overview

- Suitable for all kind of industrial application
- Frontflush pressure connection available for requirements of water applications and high viscosity media
- Standard use from -1 to 400 bar
- High accuracy over a wide temperature range (-40 ... 125 °C) due to active compensated temperature compensation
- Robust and Compact stainless housing for harsh environment conditions
- Abrasive resistant due to ceramic measurement cell
- Relative pressure and vacuum measurement
- Programmable by the FlexProgrammer 9701



### Technical data

#### Performance characteristics

Pressure type	Relative (gauged)
Compensated temperature range	-10 ... 60 °C
Long term stability	≤ 0.2 % FSR/a
Max. measuring error	± 0.3 % FSR ± 0.5 % FSR ± 1.0 % FSR Including zero-point and span error, non-linearity (by terminal base line), hysteresis and non-repeatability (EN 61298-2)
Max. measuring span	400 bar
Measuring range	-1 ... 400 bar
Step response time	< 3 ms
Standard error of measurement (BFSL)	± 0.12 % FSR ± 0.2 % FSR ± 0.4 % FSR Including non-linearity, hysteresis and non-repeatability according BFSL
Min. measuring span	0.25 bar
Power-up time	< 50 ms
Temperature coefficient	≤ 0.05 % FSR/10 K, measuring span ≤ 0.05 % FSR/10 K, zero point

#### Process conditions

Process temperature	With NBR seal: -25 ... 100 °C @ -1 ... 400 bar With EPDM seal: -40 ... 125 °C @ -1 ... 160 bar -30 ... 100 °C @ 160 ... 400 bar With FKM (Viton®) seal: -10 ... 125 °C @ -1 ... 400 bar With FVMQ seal: -40 ... 125 °C @ -1 ... 160 bar
Process pressure	Refer to section "Operating conditions"

#### Process connection

Connection variants	Refer to section "Dimensional drawings"
---------------------	---

#### Process connection

Wetted parts material	AISI 304 (1.4301) AISI 316L (1.4404) Ceramic, 96% AL2O3 NBR, optional EPDM, optional FKM (Viton®), optional FVMQ, optional
-----------------------	--

#### Ambient conditions

Operating temperature range	Connector M12-A, 4-pin: -40 ... 105 °C, with voltage output -40 ... 115 °C, with current output @ voltage supply range 26.4 ... 35 V DC -40 ... 125 °C, with current output @ voltage supply range 11 ... 26.3 V DC Class OT6 (EN 50155) Connector DIN EN 175301-803 A (DIN 43650 A), 4-pin: -40 ... 90 °C
Storage temperature range	-40 ... 125 °C
Degree of protection (EN 60529)	IP65, with connector DIN EN 175301-803 A (DIN 43650 A), 4-pin IP67, with connector M12-A, 4-pin IP69K, with connector M12-A, 4-pin
Insulation resistance	> 100 MΩ, 500 V DC
Insulation voltage	1 kV AC
Shock and vibration tests (EN 61373:1999, 2010)	Category 2 The respective most demanding severity levels of the issues 1999 and 2010 are applied in each Category 2
<b>Output signal</b>	
Current output	4 ... 20 mA, 2-wire 20 ... 4 mA, 2-wire
Voltage output	0 ... 10 V 1 ... 5 V 0 ... 5 V 0.5 ... 4.5 V
Load resistance	> 5 kΩ, with voltage output $R \leq (V_{DC} - 11 V) / 0.023 A$ , with current output

## PP20S industrial

Pressure sensor with ceramic cell and industrial connection

PP20S-1.####R.####.####00.004

### Technical data

#### Output signal

Short circuit protection Yes

#### Housing

Style Compact transmitter

Overall size Refer to section "Dimensional drawings"

Material AISI 304 (1.4301)

#### Electrical connection

Connector M12-A, 4-pin  
DIN EN 175301-803 A (DIN 43650 A), 4-pin

#### Power supply

Voltage supply range 11 ... 35 V DC , with current output  
14 ... 35 V DC , with voltage output

#### Compliance and approvals

EMC EN 61326-1  
EN 61000-6-2  
EN 61000-6-3

### Operating conditions

Measuring range (bar)		Proof pressure (bar)	Burst pressure (bar)
0 ... 0,25	0 ... 1		
-1 ... 0	-1 ... 0,6	0 ... 1,6	4
-1 ... 1	-1 ... 1,5	0 ... 2,5	6
0 ... 4	-1 ... 3		10
0...6	-1 ... 5		12
0 ... 10	-1 ... 9		15
0 ... 16	-1 ... 15		20
0 ... 25	-1 ... 24		35
0 ... 40	-1 ... 39	0 ... 60	50
0 ... 100			100
0 ... 160			150
0 ... 250	0 ... 400		200
			350
			500
			650

Measuring range (PSI)		Proof pressure (PSI)	Burst pressure (PSI)
0 ... 5	0 ... 15	0 ... 30	58
0 ... 60			87
0 ... 100	0 ... 160		145
0 ... 200			217
0 ... 400	0 ... 600		290
0 ... 1000	0 ... 1500		350
0 ... 3000	0 ... 6000		507
			725
			1450
			1740
			2175
			2900
			7250
			9425

### Dimensional drawings (mm)

#### Housing

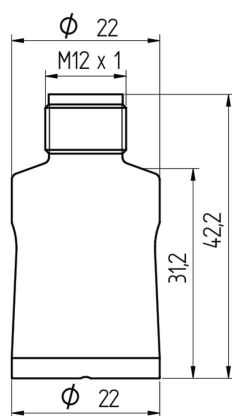

M12-A, 4-pin

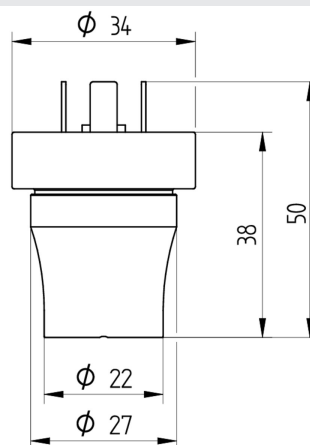

DIN EN 175301-803 A (DIN 43650 A), 4-pin

# PP20S industrial

Pressure sensor with ceramic cell and industrial connection

PP20S-1.####R.####.####00.004

## Dimensional drawings (mm)

### Process connection

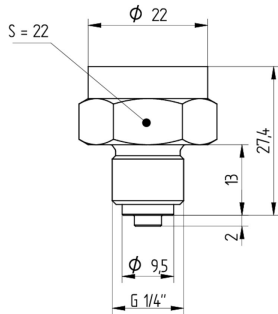

G 1/4 B EN 837-1 (G30)

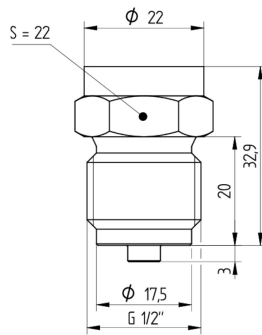

G 1/2 B EN 837-1 (G31)

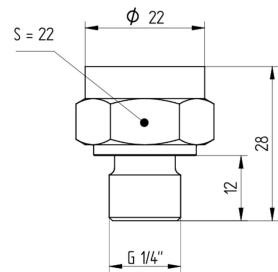

G 1/4 A DIN 3852-E (G50)

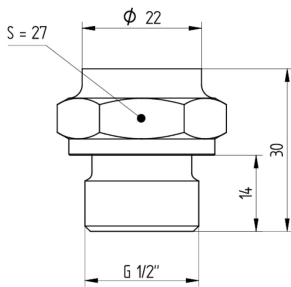

G 1/2 A DIN 3852-E (G51)

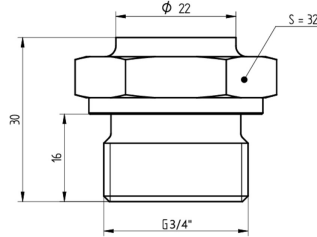

G 3/4 A DIN 3852-E (G57)

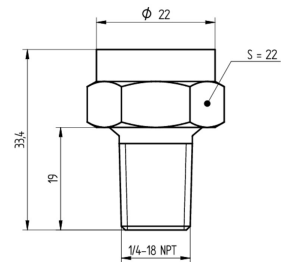

1/4 - 18 NPT (N01)

## PP20S industrial

Pressure sensor with ceramic cell and industrial connection

PP20S-1.####R.####.####00.004

### Electrical connection

Output signal	Equivalent circuit	Electrical connection	Function	Pin assignment
4 ... 20 mA (2-wire)			+Vs	1
			Iout	3
			Frame Ground	Plug thread
			n.c.	2, 4
			+Vs	1
			Iout	2
Frame Ground	Grounding lug			
0 ... 10 V (3-wire)			+Vs	1
			Uout	2, 4
			GND (0 V)	3
			Frame Ground	Plug thread
			+Vs	1
			Uout	3
GND (0 V)	2			
Frame Ground	Grounding lug			

# PP20S industrial

Pressure sensor with ceramic cell and industrial connection

PP20S-1.####R.####.####00.004

## Ordering information

Ordering key - Configuration possibilities see website

	PP20S	-	1	.	#	###	R	.	##	##	.	##	#	#	0	0	.	0	0	4
<b>Product</b>	PP20S																			
<b>Housing material</b>	SS 1.4301 AISI 304																			
						1														
<b>Accuracy</b>																				
	±1.0 % FS					1														
	±0.5 % FS					3														
	±0.3 % FS					B														
<b>Measuring range</b>																				
	0 ... 0.25 bar (EN)					B10														
	0...1 bar (EN)					B15														
	0...1,6 bar (EN)					B16														
	0 ... 2.5 bar (EN)					B18														
	0 ... 4 bar (EN)					B19														
	0 ... 6 bar (EN)					B20														
	0 ... 10 bar (EN)					B22														
	0 ... 16 bar (EN)					B24														
	0...25 bar (EN)					B26														
	0 ... 40 bar (EN)					B27														
	0 ... 60 bar (EN)					B29														
	0 ... 100 bar (EN)					B31														
	0 ... 160 bar (EN)					B33														
	0 ... 250 bar (EN)					B35														
	0 ... 400 bar (EN)					B38														
	-1...0 bar (EN)					B59														
	-1...0,6 bar (EN)					B72														
	-1...1 bar (EN)					B73														
	-1 ... 1,5 bar (EN)					B74														
	-1...3 bar (EN)					B76														
	-1...5 bar (EN)					B77														
	-1...9 bar (EN)					B79														
	-1...15 bar (EN)					B81														
	-1...24 bar (EN)					B82														
	-1...39 bar (EN)					B1L														
	0...5 psi (ANSI)					H2N														
	0...15 psi (ANSI)					H15														
	0...30 psi (ANSI)					H17														
	0...60 psi (ANSI)					H19														
	0...100 psi (ANSI)					H21														
	0...160 psi (ANSI)					H22														
	0...200 psi (ANSI)					H23														
	0...400 psi (ANSI)					H26														
	0...600 psi (ANSI)					H27														
	0...1000 psi (ANSI)					H30														
	0...1500 psi (ANSI)					H31														
	0...3000 psi (ANSI)					H34														
	0...6000 psi (ANSI)					H38														
<b>Kind of pressure</b>	Relative (gauged)						R													

# PP20S industrial

Pressure sensor with ceramic cell and industrial connection

PP20S-1.####R.####.####00.004

## Ordering information

**Ordering key - Configuration possibilities see website**

	PP20S	-	1	.	#	###	R	.	##	##	.	##	#	#	0	0	.	0	0	4
<b>Output signal</b>																				
20...4 mA										A0										
4...20 mA										A1										
0...10 V										A2										
1...5 V										A3										
0...5 V										A4										
0.5...4.5 V										A5										
<b>Output Connection</b>																				
M12-A, 4-pin																				14
DIN EN 175301-803 A (DIN 43650 A), 4-pin <sup>(1)</sup>																				44
<b>Process connection</b>																				
G 1/4 B EN 837-1 (G30)																				02
G 1/2 B EN 837-1 (G31)																				03
1/4-18 NPT (N01)																				04
G 1/4 A DIN 3852-E (G50)																				06
G 1/2 A DIN 3852-E (G51)																				09
G3/4 DIN3852-E front flush (G57)																				47
<b>Process connection material</b>																				
Stainless steel 1.4404 AISI 316L																				2
Stainless steel 1.4301 AISI 304																				4
<b>Seal</b>																				
NBR standard																				1
EPDM																				2
FKM (Viton®)																				3
FVMQ																				6
<b>Oil filling</b>																				
Without																				0
<b>Configuration</b>																				
No configuration																				0
<b>ATEX</b>																				
Without																				0
<b>Approvals</b>																				
Standard approvals																				0
<b>Technology</b>																				
Ceramic																				4

(1) Including female power connector with screwed terminals