

## 59633-2 MaxVU Rail Full Manual



## Contents

Warning Symbols Used through the Manual: .....	9
Warranty & Returns Statement .....	10
Warranty.....	10
Limitations .....	10
Installation.....	11
Guidance Notes for Installation .....	11
Implications of Double Insulation.....	11
Unpacking.....	12
Cleaning.....	12
Mounting & Unmounting .....	12
Optional bus connector.....	12
Mounting & Unmounting from DIN Rail .....	12
Electrical Installation.....	13
Installation Considerations and Advice.....	13
AC Power Wiring (100 to 240Vac versions) .....	13
Wire Isolation.....	13
Use of Shielded Cable.....	13
Noise Suppression at Source .....	14
Inductive coils.....	14
Contacts.....	14
MaxVU Rail Product Labels .....	15
Power Connection .....	16
MaxVU Rail Isolation Chart .....	16
MaxVU Rail Terminal Wiring .....	17
Temperature Sensor Identification & Connection .....	18
Sensor Placement (Thermocouple or RTD).....	18
Thermocouple .....	18
Thermocouple & RTD (PT100) Connections.....	19
Thermocouples.....	19

3 Wire RTD .....	19
2 Wire RTD .....	19
4 Wire RTD .....	19
Relay Output Details.....	20
SSR Drive Output Details.....	20
Linear Output Details.....	20
Powering Up .....	21
Powering Up Procedure.....	21
First Power Up or Factory Default .....	21
Auto-Tuning from Setup menu.....	22
MaxVU Rail Model Range .....	22
Front Panel.....	23
General Navigation & Editing.....	23
Navigating to Setup Mode or Advanced Configuration from Operator Mode .....	24
Mode Access and Lock Codes .....	24
Returning to Operator Mode .....	24
Lock Code View Screen .....	24
Time Display.....	25
Use of the Controller for Non-Temperature Applications .....	25
MaxVU Rail use as a Transmitter .....	25
Operator Mode & Screens on Standard & Extrusion models.....	26
Warnings & Messages .....	28
Pop-Up Alerts .....	28
Pop-Up Alert List.....	28
Message List.....	29
MaxVU Rail Factory Defaults .....	31
Factory Default procedure .....	31
Setup mode parameters for Standard & Extrusion models.....	32
Advanced Configuration mode for Standard & Extrusion models.....	35
User menu .....	36

Input menu .....	37
User Calibration menu.....	38
Outputs menu .....	38
Control menu for Standard model only .....	40
Control menu for Extrusion model only .....	41
Setpoint menu for Standard model only .....	43
Setpoint menu for Extrusion model only .....	44
Alarm menu .....	44
Communications menu .....	45
Display menu .....	45
Operator Screens menu .....	46
Information menu .....	47
Exiting the Advanced Configuration mode .....	47
User Calibration Menu .....	48
Single point calibration (PV Offset) .....	48
Two Point Calibration .....	49
Base Input Calibration .....	50
Equipment Required for Checking or Calibrating the Universal Input.....	50
Calibration Check .....	50
Base Calibration Procedure .....	51
Calibrating the mV Input .....	51
Calibrating other input types .....	52
Calibration Input States.....	53
Calibration Progress .....	53
Calibration Modbus Addresses.....	53
Automatic Tuning .....	54
Running the Pre-Tune .....	54
Running Tune at SP .....	55
Tuning at SP Troubleshooting.....	55
Tuning at SP for Heat and Cool.....	55

Digital Input Operation .....	56
Timer Feature.....	59
Delay, Ramp and Timer diagram .....	60
Extrusion Model Only Features.....	61
Non-Linear Cooling function .....	61
Soft Start function.....	64
Extrusion Only Parameters in the Control menu .....	65
Limiter Models .....	66
Introduction to the Limiter model .....	66
Limiter Modbus Communications.....	66
Limiter Digital Input .....	67
Limiter Operator Mode & Screens.....	68
Limiter Output Latching .....	68
Limiter Clearing Latched Outputs.....	68
Limiter Start-up Latch .....	69
Limiter Sensor Break Detection .....	69
Limiter Output 3 – Linear, Relay or SSR drive .....	69
Limiter Setup mode parameters.....	70
Limiter Advanced Configuration parameters.....	73
Limiter - Input Menu .....	73
Limiter - User Calibration Menu .....	74
Limiter - Outputs Menu.....	75
Limiter - Communications Menu.....	77
Limiter - Display Menu .....	77
Limiter - Information Menu.....	78
Limiter - Exiting from Advanced Configuration mode.....	78
MaxVU / MaxVU Rail Configurator PC Software .....	79
Firmware and Language Updating .....	81
Serial Communications.....	82
Supported Protocol .....	82

RS485 Configuration .....	82
RS485 Device Addressing.....	82
Link Layer.....	83
Supported Modbus Functions .....	84
Function Descriptions.....	84
Modbus Addresses .....	86
Commonly Used Modbus Addresses .....	86
Standard and Extrusion Modbus Addresses.....	87
Limiter Modbus Addresses .....	95
Specification for MaxVU Rail.....	100
MaxVU Rail Product Coding .....	102
Standard (MVR-x0x-xxxx-xxxx) and Extrusion (MVR-xEx-xxxx-xxxx) models.....	102
Limiter model (MVR-xTx-xxxx-xxxx) .....	103
FAQs .....	104
What happens if my Lock Code has been Changed or I forget my Lock Codes?.....	104
What is the difference between PID control & On-Off control?.....	104
My MaxVU Rail is giving an incorrect reading, what should I do?.....	105
What is an Annunciator? .....	105
What is a Limiter / Limit Controller? .....	105
What does Exceed Condition mean?.....	106
What does 'Latching' mean?.....	106
What is a Retransmit Output? .....	106
Glossary.....	107
Actual Setpoint .....	107
Alarm Hysteresis.....	108
Alarm Operation.....	109
Alarm Inhibit.....	110
Automatic Reset (Integral time) .....	110
Auto-Tune.....	110
Band Alarm Value.....	110

Basic Setpoint Control .....	110
Bias (Manual Reset) .....	110
Bumpless Transfer .....	111
Calibration - 2 Point (High/Low PV Offset) .....	111
Calibration - Single Point (PV Offset) .....	111
Control Type .....	111
Controller.....	112
Cool Proportional Band .....	112
Cycle Time .....	112
Deadband .....	112
Derivative .....	112
Deviation Alarm .....	112
Heat or Cool Output Power Limits .....	112
Heat Proportional Band .....	113
Input Filter Time.....	113
Input Range and Input Span.....	113
Limit Controller or Limiter.....	113
Loop Alarm .....	113
Manual Mode.....	114
Master & Slave.....	114
On-Off Control.....	115
On-Off Differential (Hysteresis) .....	115
PID Control.....	115
Overlap/Deadband.....	116
Pre-Tune.....	117
PV High Alarm Value .....	117
PV Low Alarm Value .....	118
Process Variable (PV) .....	118
Rate (Derivative).....	118
Reset / Integral.....	118







Reverse Acting .....	118
Scale Range Maximum.....	118
Scale Range Minimum .....	119
Serial Communications Option .....	119
Setpoint .....	119
Setpoint Upper Limit and Setpoint Lower Limit .....	119
Ramp Rate.....	120
Solid State Relay (SSR) .....	120
Solenoid Valve .....	120
Time Proportioning Control.....	121
Tuning PID.....	121
Tune at Setpoint .....	122
Running Tune at Setpoint from Automatic Control.....	122
Contact Details.....	124

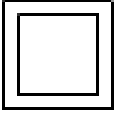

This manual supplements the Concise Product manual supplied with the instrument. Information in this manual is subject to change without notice.

Copyright © West Control Solutions, all rights reserved. No part of this publication may be reproduced, transmitted, transcribed or stored in a retrieval system, or translated into any language in any form by any means without the written permission of West Control Solutions. Copies of this manual are available in electronic format on the West Control Solutions web sites [www.west-cs.com](http://www.west-cs.com), [www.west-cs.co.uk](http://www.west-cs.co.uk), [www.west-cs.fr](http://www.west-cs.fr) & [www.west-cs.de](http://www.west-cs.de).

### Warning Symbols Used through the Manual:

	<p>Risk of electric shock. The international hazard symbol is used to alert user to hazardous voltages.</p>
	<p>Risk of Electrostatic Discharge (ESD) to components. Precautions must be taken to reduce ESD which can damage some electronic components.</p>
	<p>Caution, care must be taken, refer to the manual for further instructions.</p>
	<p>Equipment is protected throughout by double insulation, when installed properly.</p>
	<p>It is important to read this manual before installing or commissioning the unit.</p>
	<p>Important information or tip.</p>
	<p>Both alternating or direct current could be present.</p>

## Warranty & Returns Statement

This information is to be used with the published Terms & Conditions.

These products are sold by West Control Solutions under the warranties set forth in the following paragraphs. Such warranties are extended only with respect to a purchase of these products, as new merchandise, directly from West Control Solutions or from a West Control Solutions distributor, representative or reseller and are extended only to the first buyer thereof who purchases them other than for the purpose of resale.

### Warranty

These products are warranted to be free from functional defects in material and workmanship for three years from the time the products leave West Control Solutions factory and to conform at that time to the specifications set forth in the relevant West Control Solutions instruction manuals sheet or sheets.

THERE ARE NO EXPRESSED OR IMPLIED WARRANTIES, WHICH EXTEND BEYOND THE WARRANTIES HEREIN AND ABOVE SET FORTH. NO WARRANTY IS MADE OF MERCHANTABILITY OR FITNESS FOR A PARTICULAR PURPOSE WITH RESPECT TO THE PRODUCTS.

### Limitations

West Control Solutions shall not be liable for any incidental damages, consequential damages, special damages, or any other damages, costs or expenses excepting only the cost or expense of repair or replacement as described above. Products must be installed and maintained in accordance with West Control Solutions instructions. There is no warranty against damage to the product resulting from corrosion. Users are responsible for the suitability of the products to their application.

For a valid warranty claim, the product must be returned carriage paid to the supplier within the warranty period. The product must be properly packaged to avoid damage from electro-static discharge (ESD) or other forms of harm during transit.



Where there is any uncertainty in information, although we strive to have accurate translations, the UK English version will be the most accurate and up to date versions of any manuals.

## Installation

### Guidance Notes for Installation

Installation should only be performed by technically competent personnel.

It is the responsibility of the installing engineer to ensure that the configuration is safe. Local regulations regarding electrical installation & safety must be observed (e.g. US National Electrical Code (NEC) or Canadian Electrical Code).



- Standards compliance shall not be impaired when fitting into the final installation.
- Impairment of protection will occur if the product is used in a manner not specified by the manufacturer.
- Due to the low weight of this instrument there are no special lifting or carrying considerations.
- Ensure that supplementary insulation suitable for Installation Category II is achieved when fully installed.
- To avoid possible hazards, accessible conductive parts of the final installation should be protectively earthed in accordance with EN61010 for Class 1 equipment.
- Output wiring should be within a Protectively Earthed cabinet.
- Sensor sheaths should be bonded to protective earth or not be accessible.
- Live parts should not be accessible without the use of a tool.
- When fitted to the final installation, an IEC/CSA APPROVED disconnecting device should be used to disconnect both LINE and NEUTRAL conductors simultaneously.
- Do not position the equipment so that it is difficult to operate the disconnecting device.
- Ventilation slots must not be covered and adequate air circulation must be allowed.
- Use conductor sizes 30-12 AWG, minimum temp rating of cables to be 80°C.



 It is strongly recommended that applications incorporate a high or low limit protective device or 'limiter', which will shut down the equipment at a pre-set process condition, to prevent possible damage to property or products.

### Implications of Double Insulation

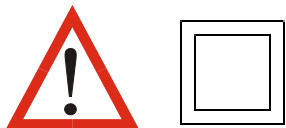

This equipment is protected throughout by double insulation, when installed properly. This type of installation does not need an earth connection, but it is vital for safety reasons, that the instrument is replaced if the instrument housing is broken.

## Unpacking

Carefully remove the product from its packing. Please retain the packing for future use. A single sheet concise manual is also supplied in one or more languages. Examine the delivered items for damage or defects. If any are found, contact your supplier immediately.

## Cleaning

Clean the front panel by wiping down with a dry cloth. Never allow water or any other substances to ingress into the instrument.

## Mounting & Unmounting

This instrument is designed for indoor back of panel use.

### Optional bus connector

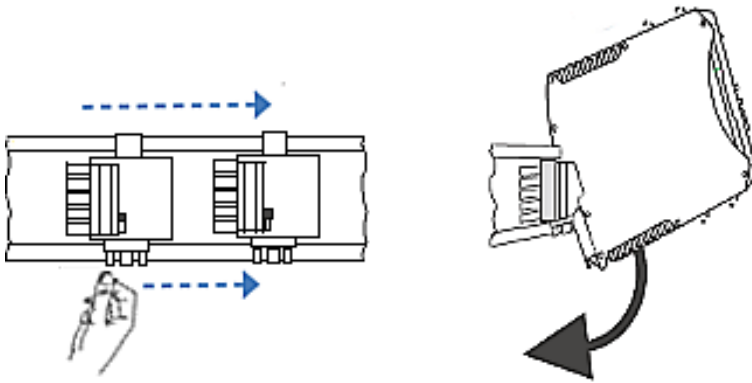

The optional bus connection should be slid onto the DIN Rail before fitting the MaxVU Rail.

The connectors must be pushed together to share the bus



This bus connection links up the optional RS485 communications connections without extra wiring but does not supply power.

### Mounting & Unmounting from DIN Rail

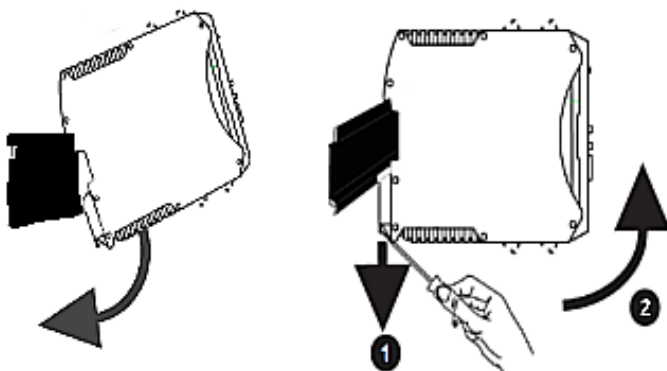

To prevent overheating, ensure the specified air-gaps are allowed, and that there is adequate air flow inside the panel. Refer to environmental specifications.

## Electrical Installation

### Installation Considerations and Advice

Ignition transformers, arc welders, motor drives, mechanical contact relays and solenoids are examples of devices that generate electrical noise in typical industrial environments. The following guidelines MUST be followed to minimise their effects.



If the instrument is being installed in existing equipment, the wiring in the area should be checked to ensure that good wiring practices have been followed.

Noise-generating devices such as those listed above should be mounted in a separate enclosure. If this is not possible, separate them from the instrument, by the largest distance possible.

If possible, eliminate mechanical contact relays and replace with solid-state relays. If a mechanical relay cannot be replaced, a solid-state relay can be used to isolate the instrument.

A separate isolation transformer to feed only the instrumentation should be considered. The transformer can isolate the instrument from noise found on the AC power input.



### AC Power Wiring (100 to 240Vac versions)

In mains power versions, it is good practice to ensure that the ac neutral is at or near ground (earth) potential. A proper neutral will help ensure maximum performance from the instrument.

### Wire Isolation

Four voltage levels of input and output wiring may be used with the unit:

- Analogue input (for example thermocouple, RTD, VDC, mVDC or mADC)
- Relays outputs
- SSR Driver outputs
- AC power

**The only wires that should run together are those of the same category.**

If any wires need to run parallel with any other lines, maintain a minimum space of 150mm between them.

If wires MUST cross each other, ensure they do so at 90 degrees to minimise interference.



### Use of Shielded Cable

All analogue signals must use shielded cable. This will help eliminate electrical noise induction on the wires. Connection lead length must be kept as short as possible keeping the wires protected by the shielding. The shield should be grounded at one end only. The preferred grounding location is at the sensor, transmitter or transducer.

## Noise Suppression at Source

Usually when good wiring practices are followed, no further noise protection is necessary. Sometimes in severe electrical environments, the amount of noise is so great that it must be suppressed at source. Many manufacturers of relays, contactors, etc. will supply 'surge suppressors' which mount on the noise source. For those devices that do not have surge suppressors supplied, Resistance-Capacitance (RC) networks and/or Metal Oxide Varistors (MOV) may be added.

### Inductive coils

MOVs are recommended for transient suppression in inductive coils, connected in parallel and as close as possible to the coil. Additional protection may be provided by adding an RC network across the MOV.

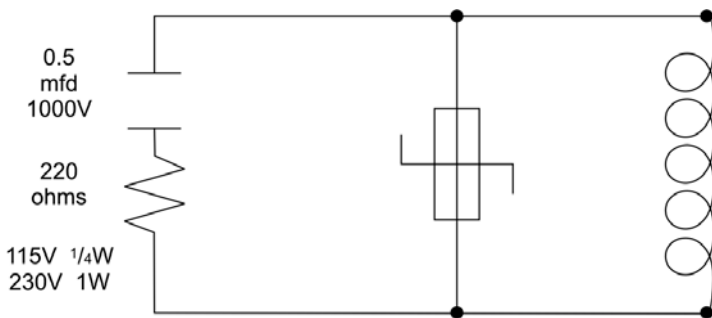

### Contacts

Arcing may occur across contacts when they open and close. This results in electrical noise as well as damage to the contacts. Connecting a properly sized RC network can eliminate this arcing.

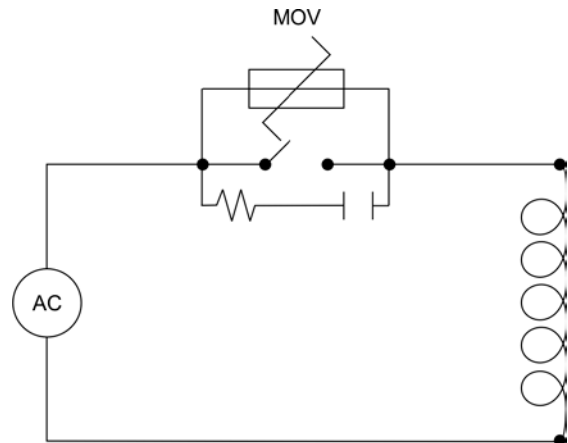

For any circuits of up to 3 Amps, a combination of a 47 Ohm resistor and 0.1 microfarad capacitor (rated at 1000 Volts) is recommended. For circuits from 3 to 5 Amps, connect two of these in parallel. Always observe the current rating of the relays on the controller and ensure this is not exceeded.

## MaxVU Rail Product Labels



The example product & wiring label below is for illustration only. Actual label information varies with the model code / hardware configuration purchased.

**WEST**  
Control Solutions  
www.West-CS.com

Model : MVR  
Config : 1TMZALC51U0 -  
Serial : 123456 - 123 - 001  
Date : 0517

PRL : BT Made In UK

CE  
UL US LISTED  
E208029

The product label shows the part number, production information and approvals.

Model and Config codes make up the part number (see MaxVU Rail Product Coding section), followed by the unit serial number, country & date of manufacture, and Product Revision Level.

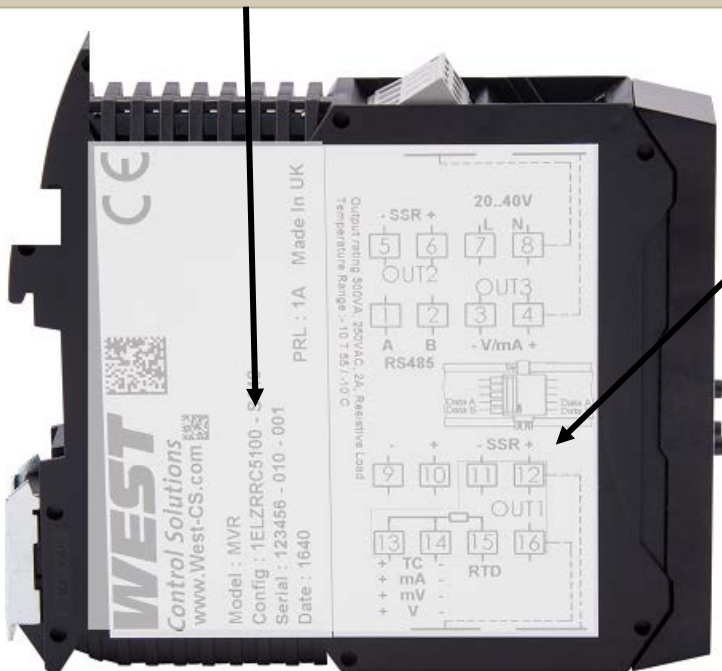

**100-240V**  
50/60Hz 9VA

! (Warning symbol)

OUT2: 5 (-SSR), 6 (+SSR)

OUT3: 3, 4

RS485: 1 (A), 2 (B), 3 (V/mA), 4 (V/mA)

DI: 9 (-), 10 (+), 11 (Com), 12 (N/O)

OUT1: 11 (Com), 12 (N/O), 16 (N/C)

Process Input: 13 (RTD), 14 (+ TC), 15 (+ mA), 16 (+ mV), 16 (+ V)

Output rating : OUT1 (250VAC, 2A), OUT2/3, (250VAC, 2A), Resistive Load  
Minimum temperature rating of cables to be 80°C

The wiring label shows the power requirements, connector positions and terminal number.

This example is:

TOP

- 1 & 2 Rear = RS485 Comms
- 3 & 3 Rear = Linear Out 3
- 5 & 6 Front = SSR Driver Out 2
- 7 & 8 Front = 100-240VAC power.

BOTTOM

- 9 & 10 Rear = Digital Input
- 11, 12 Rear & 16 Front = Relay Out 1
- 13, 14 & 15 Front = Process Input

## Power Connection

To avoid damaging your instrument it is critical the power connection is made to the correct terminals.



Power is connected to pins 7 & 8.  
Top, rear connector on the right-hand side.  
(front connector omitted from picture for clarity)

The green LED shows when power is correctly connected.

	Not Applicable
	No Isolation
	Reinforced Isolation

## MaxVU Rail Isolation Chart

	PSU	Universal Input	Relay	SSR	Linear	RS485 Comms	Non-Isolated Digital Input	Isolated Digital Input	Configuration Port
PSU									
Universal Input									
Relay									
SSR									
Linear									
RS485 Comms									
Non-Isolated Digital Input									
Isolated Digital Input									
Configuration Port									



## MaxVU Rail Terminal Wiring



**Caution:** Check information label on housing for correct operating voltage before connecting supply to Power Inputs.

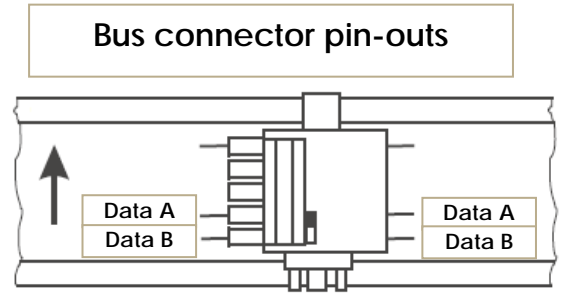
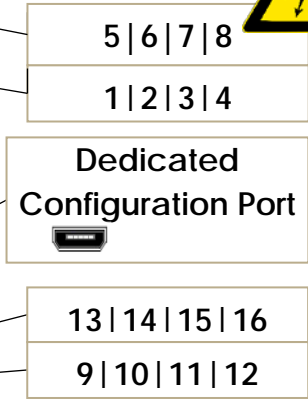
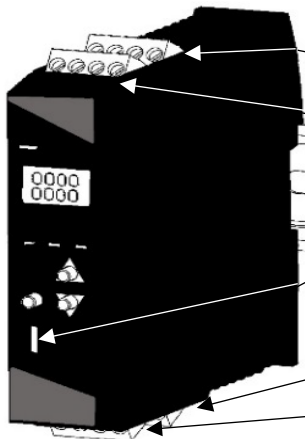

Never directly connect the dedicated configuration socket to a USB port, use adaptor CONV-BA-00-00-00-MV.

Diagrams show all possible option combinations so check your exact product specification before connecting.

Use cables with 80°C minimum temperature rating, conductor sizes 30-12 AWG.

1	RS485 A (Rx/Tx+)	Communications	
2	RS485 B (Rx/Tx-)		
3	Relay COM / Linear +	Output 3 – Standard & Extrusion models	Output 3 (Alarm 2 or Retx PV) – Limiter model
4	Relay NO / Linear -		
5	Relay COM / SSR-	Output 2 – Standard & Extrusion models	Alarm 1 output – Limiter model
6	Relay NO / SSR+		
7	L +	Power – low power or mains (hardware dependent)	
8	N -		
9	Volt-free or TTL compatible	Digital Input	
10			
16	Relay NC	Output 1 – Standard and Extrusion models	Limit output – Limiter model
11	Relay COM / SSR-		
12	Relay NO / SSR+		
13	RTD	Input – thermocouple, RTD or linear	
14	TC / RTD / Linear +		
15	TC / RTD / Linear -		

## Temperature Sensor Identification & Connection

### Sensor Placement (Thermocouple or RTD)

If the temperature probe is to be subjected to corrosive or abrasive conditions, it must be protected by an appropriate thermo-well. The probe must be positioned to reflect true process temperature:

- In a liquid media - the most agitated area
- In air - the best circulated area

The placement of probes into pipe work some distance from the heating vessel leads to 'transport delay', which results in poor control.

Locate the MaxVU as close as practical to the sensor to keep lead-length to a minimum.

### Thermocouple

Thermocouples are identified by wire colour, and where possible, the outer insulation as well. IEC584-3 is the most common standard, but several standards have been used worldwide. This therefore is only a guide.

Type		International IEC584-3	USA ANSI MC 96.1	British BS1843	French NFC 42-324	German DIN 43710
J	+	Black Black	White Black	Yellow Black	Yellow Black	Red Blue
	-	White Black	Red Black	Blue Black	Black Black	Blue Blue
T	+	Brown Brown	Blue Blue	White Blue	Yellow Blue	Red Brown
	-	White Brown	Red Blue	Blue Blue	Blue Blue	Brown Brown
K	+	Green Green	Yellow Yellow	Brown Red	Yellow Yellow	Red Green
	-	White Green	Red Yellow	Blue Red	Purple Yellow	Green Green
N	+	Pink Pink	Orange Orange	Orange Orange		
	-	White Pink	Red Orange	Blue Orange		
B	+	Grey Grey	Grey Grey			Red Grey
	-	White Grey	Red Grey			Grey Grey
R & S	+	Orange Orange	Black Green	White Green	Yellow Green	Red White
	-	White Orange	Red Green	Blue Green	Green Green	White White
C (W5)	+		White White			
	-		Red White			



**Note:**

\* = Wire is magnetic

+ Wire	Sheath
- Wire	



**Important:** Using the wrong type of extension cable will cause incorrect readings.

	Lead Colours	
PT100	White	Red
	Red	Red

Refer also to the Input Type range table in the Setup menu.

## Thermocouple & RTD (PT100) Connections

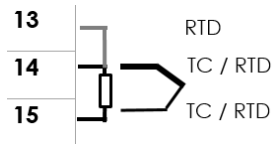

### Thermocouples

Connect your thermocouple to terminals 14 (positive) & 15 (negative). Carefully follow the chart above, because correct polarity is vital for proper operation.

### 3 Wire RTD

The MaxVU Rail is designed to support a compensated 3 wire PT100. A PT100 normally 1 white and 2 red wires. The resistive element is between the white (connect to terminal 15) & 1 red wire (connect to terminal 14). The 2nd red wire (connect to terminal 13) is required for automatic lead length compensation.

### 2 Wire RTD

It is recommended to use a 3-wire PT100 RTD sensor. 2-wire PT100s should only be used with lead lengths less than 3 metres. To use a 2-wire PT100 connect to terminals 14 & 15, then place a wire link between terminals 13 & 14 in place of the third wire.

### 4 Wire RTD

A 4-wire PT100 can be used provided it is connected as a 3-wire type, with the 2<sup>nd</sup> white wire is not used.

The resistive element is between the 1 white wire (connect to terminal 15) & 1 red wire (connect to terminal 14). The 2<sup>nd</sup> red is connected to terminal 13 for the automatic lead length compensation. The remaining white wire must be left unconnected (cut short or tied back to prevent it touching other connections).

## Relay Output Details

Relays are rated for 2A maximum at 250Vac (resistive load).

*Output 1 (Relay option) Form A SPDT*

*Output 2 or Output 3 (Relay option) Form C SPST*

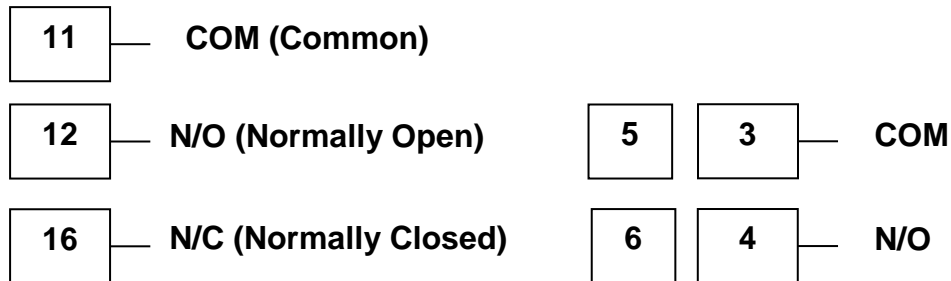

## SSR Drive Output Details

The SSR driver outputs give a >10VDC 'on' signal at 20mA maximum. Use a separate connection to the +ve & -ve of each output. Do not common together.

*Output 1 (SSR Drive option)*

*Output 2 or Output 3 (SSR Drive option)*

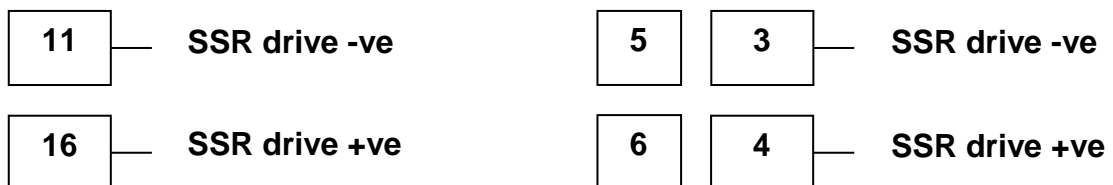

## Linear Output Details

The Linear Output is an option for Output 3. Select from 0 to 10V, 2 to 10V, 0 to 20mA, 4 to 20mA, 0 to 5V or 1 to 5V in the setup or input configuration menus.

*Output 3 (Linear option)*

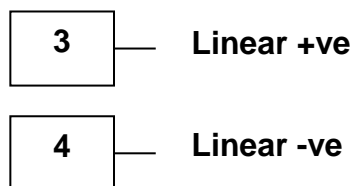

## Powering Up

ENSURE SAFE WIRING PRACTICES HAVE BEEN FOLLOWED.  
WHEN POWERING UP FOR THE FIRST TIME, ISOLATE THE POWER FROM THE OUTPUT CONNECTIONS.



The instrument must be powered from a supply according to the wiring label on the side of the unit. (100vac to 240Vac, or 24 Vac/dc depending upon the model purchased.)

**Carefully check the supply voltage and connections before applying power.**

## Powering Up Procedure

At power-up, a self-test procedure is run, during which a product logo screen is displayed. When powering up for the first time the instrument starts up in the Setup Mode after the product logo screen is displayed.











You must complete the Setup by cycling through all parameters before exiting the Setup Mode, and using the device for the first time. Otherwise the device will go into the Setup Mode, again, on subsequent power ups.

Once it has been correctly set-up, the instrument will enter the Operator Mode, after self-test, and any future access to the Setup or Advanced Configuration Modes is lock code protected.

## First Power Up or Factory Default

When the unit is initially powered up or the user restores the factory defaults to the device, it immediately enters the Setup menu without requiring an unlock code. The user must then cycle through every parameter, to either view or adjust the value, and then exit the menu.

1. Use  or  to review every parameter.
2. Change value if necessary using , then use  or  to adjust the value, then  to save.
3. Exit Setup by pressing  &  together.

If the above steps are not followed the Setup has not been completed so the device will go into Setup, again, on every subsequent power up.

The Pop-Up alert "**Setup not Complete**" may appear as a reminder that you need to finish the Setup.

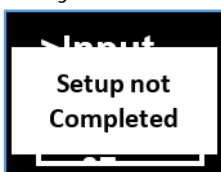

## Auto-Tuning from Setup menu

The controller can be auto-tuned from the Setup Mode.

### 1. Pre-tune

Pre-Tune auto-tuning will not engage if:

- Controller is set to On/Off control (**Heat Proportional Band** or **Cool Proportional Band** = **On.Off**)
- Setpoint is ramping (**Ramp Rate** is not **OFF**)
- PV is within 5% of the input range (scale range) from Setpoint (applies for Pre-Tune only).

### 2. Auto-tune at setpoint







Auto-tune at setpoint auto-tuning will not engage if:

- Controller is set to On/Off control (**Heat Proportional Band** or **Cool Proportional Band** = **On.Off**)
- Setpoint is ramping (**Ramp Rate** is not **OFF**)
- Start Tune at SP is not available for Heat & Cool processes.

Please also refer to the Automatic Tuning section for tuning advice.

## MaxVU Rail Model Range

The MaxVU Rail has 3 different model types – Standard, Extrusion and Limiter. The table below shows some easily recognisable differences and explains their intended purpose.

Type	Purpose	Start-up Splash screen	Status LEDs
Standard	General temperature and other applications – PID or On/Off control.		1 2 3 
Extrusion	Plastic extrusion applications – PID or On/Off control.		 
Limiter	Over or Under PV prevention, without control functions.		LM EX AL 

All models have mechanical characteristics, specifications and many of the parameters in common. However, there is a separate section with more information focused on the Limiter.

The tables and parameters applicable to all models have grey or brown borders.

The parameters tables specific to the Standard and Extrusion models are blue, and the Limiter specific areas are green.

## Front Panel

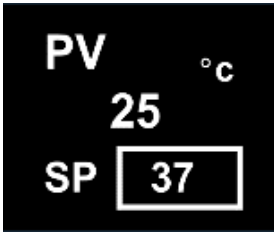

Display shows PV (process variable), units, SP (setpoint), alarm/latch statuses, error & warning messages.

By default, the display turns off after 5 minutes without any key presses. This is configurable in the Advanced Configuration, in the Display sub-menu, parameter **Screen Timeout**. Any key press turns the display back on.



The main screen showing PV & SP, and the subsequent screens accessed from it using or , are called the Operator Screens or Operator Mode.

3 navigation keys:

- Ok/Select
- Up
- Down

**Standard:**  
3 Output Status LEDs

1	2	3

**Extrusion:**  
3 Status LEDs for:  
**Heat Cool Alarm**

**Limiter:**  
3 Status LEDs for

LM	EX	AL



°C or °F are shown for temperature inputs only. Blank for linear type input (i.e. mA, V or mV).

## General Navigation & Editing

The device detects what options are fitted and intelligently hides parameters that are not relevant to your current configuration.



These navigation instructions are common to all versions of the MaxVU Rail.

Press or keys to navigate between parameters or menu items.

Press to highlight a parameter value, ready for editing.

Press or to change the parameter value, then press within 60 seconds to confirm change.

For example, changing the setpoint (**SP**). This example is for Standard or Extrusion models.

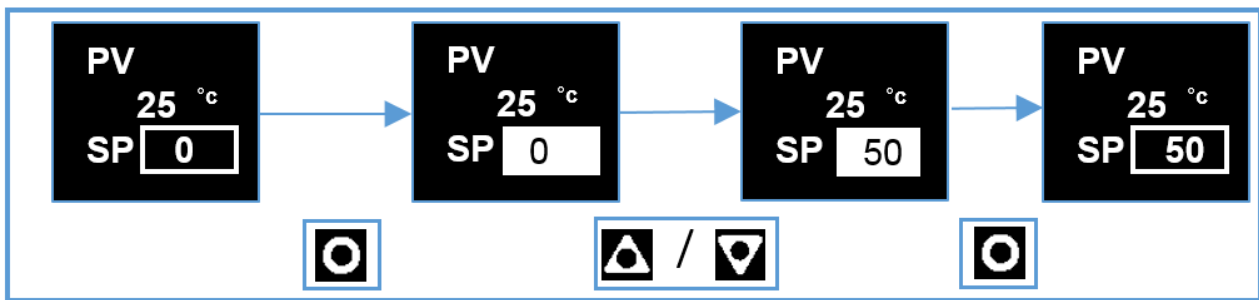

## Navigating to Setup Mode or Advanced Configuration from Operator Mode

Setup Mode - press & .

Advanced Configuration - press & .

The Setup Mode has fewer parameters and is intended for quick set up of simple applications. Advanced Configuration gives access to all parameters for more complex application.

## Mode Access and Lock Codes

Separate lock codes can be set for the Setup mode and for the Advanced Configuration mode.

Setup mode lock code – default **10**.

Advanced Configuration mode lock code – default **20**.

## Returning to Operator Mode

Press & to move back one level (from Advanced Configuration sub-menus you may need to move up 2 or more levels). After 120 seconds without key presses the unit returns automatically to the first Operator mode screen.

## Lock Code View Screen

If you don't know the lock codes for any of the password protected menus, they can be found as follows:



Hold the button whilst powering up for the lock code view screen and from this screen the lock-codes (passwords) can be seen or changed. Be patient, it takes approx. 30 seconds to enter this screen at start-up.

Press & to exit.



## Time Display

Time values are displayed on the MaxVU Rail as shown in the examples below.

minutes:seconds



hours:minutes

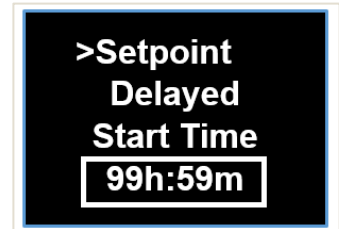

## Use of the Controller for Non-Temperature Applications

In this controller, the Primary and Secondary outputs are referred to as "HEAT" and "COOL".

The majority of applications for the Standard model controller involve temperature measurement and control, either via a direct sensor or indirectly via a linear dc input. However, this model can also be used for other process types, such as Relative Humidity, for example.





If your process is not temperature, then the parameters labelled as "HEAT" refer to reverse acting outputs used to increase the process value and "COOL" to decrease the process value. As an example, you may have a system that reads and controls humidity. The "HEAT" output drives the humidifier (adding moisture) and the "COOL" output drives the de-humidifier (extracting the moisture from the air). Use the "HEAT" parameters to control the humidifier and the "COOL" parameters to control the de-humidifier.

## MaxVU Rail use as a Transmitter

The Standard MaxVU Rail model can be used as a "transmitter" to retransmit the process value or controller setpoint via Output 3, if the linear option is fitted. The parameter **Usage** in the **Linear Output** sub-menu can be set to **PV Retransmit** or **SP Retransmit**.

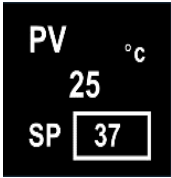
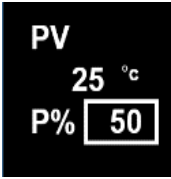
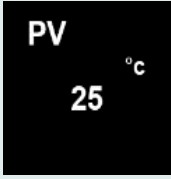
In the **Display** menu, the parameter **Transmitter** can be used to enable Transmitter view. This hides the Setpoint from view. Note: control functions will remain active if they have been configured.

## Operator Mode & Screens on Standard & Extrusion models

User Screen		<p>Temperature Unit.            PV – process variable (e.g. process temperature)            SP - Setpoint</p>
Manual control		<p>PV – process variable (e.g. process temperature)            Manual Power is shown as <b>P%</b>.</p>
<b>Transmitter screen is present on Standard model only.</b>		
Transmitter view enabled		<p>Transmitter parameter = <b>Enable</b>, SP is hidden.</p> <p><b>Important:</b> The device still functions as a controller using the local Setpoint.</p> <div style="text-align: right;"></div> <p>To act as a PV transmitter the parameter <b>Usage</b> in the <b>Linear Output</b> sub-menu needs to be set to <b>PV Retransmit</b>.</p>
<b>Important:</b> The following parameters are only displayed if set to “ <b>Show</b> ” in the <b>Operator</b> sub-menu.		
Alarm State		<div style="text-align: right;">  Alarm triggered         </div> <div style="text-align: right; margin-top: 10px;">  Alarm configured, but not triggered         </div> <div style="text-align: right; margin-top: 10px;">           – Alarm not set         </div>

<b>Latch State</b>	<div style="background-color: black; color: white; padding: 5px; border: 1px solid black;"> <p>Latch State</p> <p>Out 1 "/&gt;</p> <p>Out 2 </p> <p>Out 3 </p> </div>	<p> Output Latched</p> <p> Latch configured, but output not Latched</p> <p> - Latch not set</p>	<p>To clear press </p> <p>then  to select <b>Yes</b>.</p> <p>Press  to accept.</p>
<b>Maximum PV</b>	<div style="background-color: black; color: white; padding: 5px; border: 1px solid black;"> <p>Maximum PV</p> <div style="border: 1px solid white; padding: 2px; display: inline-block;">31°C</div> </div>	Screens show the Maximum & Minimum PV reached.	<p>To clear press </p> <p>then  to select "Yes".</p> <p>Press  to accept.</p>
<b>Minimum PV</b>	<div style="background-color: black; color: white; padding: 5px; border: 1px solid black;"> <p>Minimum PV</p> <div style="border: 1px solid white; padding: 2px; display: inline-block;">23°C</div> </div>		
<b>Control Enable</b>	<p><b>OFF</b> - Control output(s) disabled. (Ignored when in manual mode).</p> <p><b>ON</b> - Control output(s) enabled.</p>		
<b>Manual Control Enable</b>	<p><b>OFF</b> - Automatic control, PID or On-Off control available.</p> <p><b>ON</b> - Manual control, Manual Power shown as <b>P% xxx</b>.</p>		
<b>Time On Remaining</b>	<i>On Timer</i>	<p>Visible when On Timer is active.</p> <p>See Ramp &amp; Timers diagram.</p>	
<b>Delay Time Remaining</b>	<i>Delay Timer</i>	<p>Visible when Delay Timer is active.</p> <p>See Ramp &amp; Timers diagram.</p>	

## Warnings & Messages





Do not continue running your process until any issues are resolved.

### Pop-Up Alerts

Pop-up alerts appear in front of the current screen. They must be acknowledged before you can access other screens.



For example, Pop-up alert for Alarm 1.

Press  and  together to clear the pop-up alert.

### Pop-Up Alert List

Message	Description
Alarm 1	Alarm 1 is active.
Alarm 2	Alarm 2 is active.
Alarm 1 & 2	Alarm 1 and 2 are active.
Control Enabled	Alerts user that the control is re-enabled. (not Limiter.)
Calibration Pass	Factory calibration (Full Input Calibration has passed.)
Calibration Fail	Factory calibration (Full Input Calibration has failed.)
Tuning in Progress	Tune at Setpoint or Pre-Tune is running. (Not Limiter.)
Setup not completed	Please refer to First Power Up or Factory Default section.
Offset in use	SP offset is being used in Setpoint sub-menu.
Limit Exceeded	Limiter only, indicates when the limit value has been exceeded.
Tune Error PV within 5% of SP	PV within 5% of the scale range input from SP (for Pre-Tune). Try a different setpoint or narrow the scale range input.
Tune Error Setpoint is ramping	Setpoint is ramping. Turn off ramping and try again.
Tune Error Control is ON/OFF	Control is not set to PID, i.e. the proportional band = 0. Set the proportional band to any other value and try again.
Tune Error Control is manual	Manual control enabled. Set Manual Control Enable to OFF and try again.
Tune Error Tune at Setpoint not able to run	Tune at setpoint has timed out or cannot run.

Message	Description
Tune Error Sensor Break	Check your sensor.
Tune Error Timer Running	Timer Running. Set the Enable Timer parameter to Disabled.

## Message List

Messages seen in the operator mode.

Message	Description
<b>ALARM</b>	Alternates with PV and shows one, or both, Alarms are active.
<b>LATCH</b>	Alternates with PV, one or more outputs are latched on & no alarm is active.
<b>LIMIT</b>	On Limiter model, alternates with PV to show Limit is active.
<b>HIGH</b>	Process variable input >5% over-range. Check for possible issues with sensor or connections. Also, check that <b>Scale Range Maximum</b> is high enough for your application.
<b>LOW</b>	Process variable input >5% under-range. Check for possible issues with sensor or connections. Also, check that <b>Scale Range Minimum</b> is low enough for your application.
<b>OPEN</b>	Break detected in process variable input sensor, wiring or wrong input type selected. Shows <b>OPEN</b> until resolved, Control is disabled on Standard or Extrusion models), or Limit state set until resolved on Limiter model.
<b>ERROR</b>	Selected input range is not calibrated. Shows <b>ERROR</b> until resolved, Control is disabled on Standard or Extrusion models), or Limit state set until resolved on Limiter model.
<b>TUNE</b>	Alternating with SP shows Auto-tuning is in progress.
<b>P%</b>	Manual power value replaces setpoint, shows <b>P% xxx</b> of power.
<b>Ramp</b>	Setpoint ramp is active (alternates with actual setpoint).
<b>OFF</b>	Control is disabled. Control output(s) are off. Enable control by setting <b>Control Enable</b> to <b>ON</b> or check state of the Digital Input if <b>Digital I/P Action</b> is set to <b>Ctrl Enable/Disable</b> .
<b>DELAY</b>	Shows when Delay Timer is active, control is off until the timer finishes.
<b>Tuning messages</b>	
	The <b>Automatic Tuning</b> parameter must be changed to <b>Off</b> to clear any tuning message. Display alternates between the tuning code & setpoint.
<b>tErr1</b>	PV within 5% of the scale range input from SP (for Pre-Tune). Try a different setpoint or narrow the scale range input.
<b>tErr2</b>	Setpoint is ramping.
<b>tErr3</b>	Control is ON/OFF. Control is not set to PID, i.e. the proportional band = 0.

Tuning messages



The **Automatic Tuning** parameter must be changed to **Off** to clear any tuning message. Display alternates between the tuning code & setpoint.

<b>tErr4</b>	Control is manual. Set <b>Manual Control Enable</b> to <b>OFF</b> .
<b>tErr5</b>	Tune at Setpoint not able to run.
<b>tErr6</b>	Sensor Break.
<b>tErr7</b>	Timer Running. Set the <b>Enable Timer</b> parameter to <b>Disabled</b> before attempting to run tuning again.
<b>tErr8</b>	Control is disabled. Please check it is safe to enable control and then go to the User menu to change <b>Control Enable</b> to <b>ON</b> .









## MaxVU Rail Factory Defaults

The factory default values for parameters are shown in the right-hand column of the parameter lists. When the factory default process is performed all the parameters will be returned to these values.



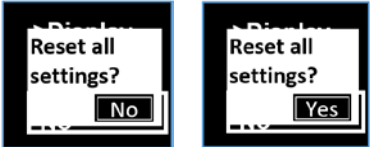

The **Reset to Defaults** can be found in the sub-menu Display in the Advanced Configuration on all models.

### Factory Default procedure

	<p>Press  to highlight <b>No</b>.</p>
	<p>Press  to move highlight to <b>Yes</b>. Press  to accept.</p>
	<p>A confirmation screen appears.</p> <p>If you are sure press  to show <b>Yes</b> (leave as <b>No</b> to cancel). Press  to confirm your choice.</p>
	<p>The instrument shows the default for the Input Type and its default value.</p> <p>The user must review all parameters in the Setup menu before exiting.</p>

## Setup mode parameters for Standard & Extrusion models

If necessary, press  &  to enter Setup from Operator mode.

Enter code for **Setup Lock** (default = 10) using  & , then press .



1. For the Limiter model refer to the Limiter Model focus section.
2. Some parameters may be hidden depending on the model or other settings.
3. Note the permissible ranges for each temperature sensor type, below. For example, the B type thermocouple readings cannot have a decimal point, and it cannot measure below 100 °C or above 1824 °C
4. Where allowed the number of decimal points is set by the **Decimal Place** parameter.

The table below continues onto the next page.

Parameter	Description		Default Value
* Maximum of 1 decimal place for temperature inputs J, K, L, T & PT100.			
>Input Type	<b>J Thermocouple *</b>		<b>K Thermocouple</b>
	-200 – 1200°C	-128.8 – 537.7°C	
	-328 – 2192°F	-199.9 – 999.9°F	
	<b>K Thermocouple *</b>		
	-240 – 1373°C	-128.8 – 537.7°C	
	-400 – 2503°F	-199.9 – 999.9°F	
	<b>PT100 *</b>		
	-199 – 800°C	-128.8 – 537.7°C	
	-328 – 1472°F	-199.9 – 999.9°F	
	<b>B Thermocouple</b>		
	100 – 1824°C	211 – 3315°F	
	<b>C Thermocouple</b>		
	0 – 2320°C	32 – 4208°F	
	<b>L Thermocouple *</b>		
0 – 762°C	0.0 – 537.7°C		
32 – 1403°F	32.0 – 999.9°F		
<b>N Thermocouple</b>			
0 – 1399°C	32 – 2551°F		
<b>R Thermocouple</b>			
0 – 1795°C	32 – 3198°F		
<b>S Thermocouple</b>			
0 – 1762°C	32 – 3204°F		
<b>T Thermocouple *</b>			
-240 – 400°C	-128.8 – 400.0°C		
-400 – 752°F	-199.9 – 752.0°F		







Parameter	Description	Default Value
	Linear dc	
	0 – 20mA	4 – 20mA
	0 – 50mV**	10 – 50mV
	0 – 5V	1 – 5V
	0 – 10V	2 – 10V
** 0 – 50mV is only linear dc input available on Extrusion models.		
>Input Units	°C or °F	°C
Units parameter hidden when linear input is used and units are not shown on the display		
>Input Decimal Place	0000 – no decimal point 000.0 – one decimal point 00.00 – two decimal points ( <i>linear dc only</i> ) 0.000 – three decimal points ( <i>linear dc only</i> )	0000
Scale Range maximum & minimum are only visible when input is a linear dc type.		
>Input Scale Range Maximum	Maximum for user working range.	1000
>Input Scale Range Minimum	Minimum for user working range.	0
>Input Digital I/P Action	None Alarm Reset ( <i>clears latched alarms</i> ) Ctrl Enable/Disable ( <i>disables control</i> ) Ctrl Auto/Manual Pre-Tune Start/Stop Tune at SP Start/Stop	None
>Output 1 Usage	Heat Cool Non Linear Cooling ( <i>on Extrusion model only</i> ) Alarm 1 Alarm 2 Alm. 1or 2 ( <i>logical 'OR' of Alarm 1 &amp; 2</i> ) Loop Alarm	Heat
>Output 2 Usage	Same options as Output 1 Usage	Alarm 1
>Output 3 Usage	Same options as Output 1 Usage	Alarm 2
If a Relay or SSR drive is fitted in Output 3 you will see >Output 3.		
If the Linear option is fitted in Output 3 you will see the >Linear Outp menus instead.		

Parameter	Description	Default Value
>Linear Outp Usage	Heat Cool PV Retx SP Retx	PV Retx
>Linear Outp Type	0-10V 2-10V 0-20mA 4-20mA 0-5V 1-5V	0-10V
>Linear Outp Scale Range Maximum	Maximum PV or SP value corresponding to maximum linear output for retransmission.	1373
>Linear Outp Scale Range Minimum	Minimum PV or SP value corresponding to minimum linear output for retransmission.	-240
>Alarm 1 Value	Range minimum to range maximum, or OFF (maximum +1). <b>OFF</b> disables alarm. Default <b>PV High</b> alarm type.	1373
>Alarm 2 Value	Same options as Alarm 1. Default <b>PV Low</b> alarm type.	-240
Setpoint	Target setpoint.	0
>Coms Unit Address	Modbus address from 1 to 255	1
>Coms Baud Rate	1200, 2400, 4800, 9600, 19200 & 38400 bps	9600
>Coms Parity	Odd, Even or None	None
>Control Automatic Tuning	Off, Start Pre-Tune or Start Tune at SP ***	Off



1. \*\*\* The **Start Tune at SP** function is not available for Heat & Cool processes.
2. If the **Input Type** is changed, input scaling and alarm values are set to new values based on the maximum and minimum of the new input type. If necessary, review these settings.

If necessary, press  and  to clear the "Control is Enabled" Pop Up Alert then press  &  to exit the Setup mode.

## Advanced Configuration mode for Standard & Extrusion models

The Advanced Configuration mode gives access to all the parameters accessible from the front panel; however, the device hides parameters that are not relevant to your exact model code specification & configuration.

The Advanced Configuration mode has eleven menus, some of which contain further sub-menus.

Menu Name (letters are sub-menus)	
1. User	7. Alarms a) Alarm 1 b) Alarm 2 c) Options
2. Input	8. Communication
3. User Calibration	9. Display
4. Outputs a) Output 1 b) Output 2 c) Output 3 or Linear Outp	10. Operator Screens
5. Control	11. Information
6. Setpoint & Timer	



Please refer to the Limiter Model for those models.

The Setpoint can be locked by setting **Setpoint Upper Limit** and **Setpoint Lower Limit** to the same value.



For basic applications, it may be sufficient to use the simpler Setup mode to set-up. See previous sections.

Otherwise, press  &  to enter Advanced Configuration from Operator screen.

Enter **Advanced Lock-code** (default of **20**) using  and , then press .

## User menu

Applicable to both Standard & Extrusion models.

Parameter	Description	Default Value	
Alarm State		<p> Alarm triggered</p> <p> Alarm set, but not triggered</p> <p style="text-align: center;">- Alarm not set</p>	n/a
Latch State		<p> Output Latched</p> <p> Latch configured, but output not Latched</p> <p style="text-align: center;">- Latch not set</p>	n/a
<p>To clear any latched outputs, press  then  to select <b>Yes</b>. Press  to accept.</p>			
Maximum PV	<p>To clear the stored value press  then  to select <b>Yes</b>. Press  to accept.</p>	Screens show the Maximum & Minimum PV reached.	
Minimum PV			
Control Enable	<p><b>OFF</b> - Control output(s) disabled. (Ignored when in manual mode). <b>ON</b> - Control output(s) enabled.</p>	<b>ON</b>	
Manual Control Enable	<p><b>OFF</b> - Automatic control, PID or On-Off control available. <b>ON</b> - Manual control, Manual Power shown as <b>P% xxx</b></p>	<b>OFF</b>	

## Input menu

Applicable to Standard & Extrusion models.

Parameter	Description	Default Value
Input Type	Refer to Input types in the table in the Setup menu section for a full list of inputs available.	K thermocouple
Units	Display Units either °C or °F. This parameter is hidden when input is a linear type and °C or °F are hidden from the display.	°C
Units hidden when linear input is used and no unit is shown on the display		
Decimal Place	0000 000.0 00.00 ( <i>not for temperature</i> ) 0.000 ( <i>not for temperature</i> )	0000
Scale Range Maximum	For temperature inputs, enter the maximum working range. For linear inputs, enter the display value for the maximum input level	Maximum allowed for Input Type.
Scale Range Minimum	For temperature inputs, enter the minimum working range. For linear inputs, enter the display value for the minimum input level.	Minimum allowed for Input Type.
Filter Time	Input filter time value to reduce noise. <b>OFF</b> or <b>0.5</b> to <b>100.0</b> seconds in <b>0.5</b> increments	2.0
CJC Enable	<b>Enable</b> Enables the internal thermocouple CJC (Cold Junction Compensation). <b>Disable</b> Disables the internal CJC. If disabled, external compensation must be provided.	Enable
Digital I/P Action	None Alarm Reset ( <i>clears latched alarms</i> ) Ctrl Enable/Disable ( <i>disables control</i> ) Ctrl Auto/Manual Pre-Tune Start/Stop Tune at SP Start/Stop	None



The input scale range, consisting of **Scale Range Maximum** & **Scale Range Minimum** above, is used to narrow the working range of the controller.

If the measured value is more than 5% above or below the scaled range PV display is replaced by **HIGH** (over-range) or **LOW** (under-range).

The scale range also affects if Pre-Tune will run. If the PV is <5% of the scaled range from setpoint Pre-Tune cannot be used.

## User Calibration menu

Applicable to Standard & Extrusion models.

Parameter	Description	Default Value
Offset	Shifts the input value up or down by this offset value, across the entire range.	0
Low Point	Enter value at which the low point error was measured.	Lower Limit
Low Offset	Enter equal, but opposite offset value to the observed low point error.	0
High Point	Enter value at which the high point error was measured.	Upper Limit
High Offset	Enter an equal, but opposite offset value to the observed high point error.	0

## Outputs menu

Applicable to Standard & Extrusion models.

Parameter	Description	Default Value
<b>Output 1 sub-menu</b>		
Usage	Heat ( <i>Reverse acting control</i> ) Cool ( <i>Direct acting control</i> ) Non Linear Cooling ( <i>Extrusion model only</i> ) Alarm 1 Alarm 2 Alm. 1or2 ( <i>i.e. logical 'OR' of Alarm 1 &amp; 2</i> ) Loop Alarm	Heat
Alarm Action	<b>Direct</b> - Output active when alarm triggers <b>Reverse</b> - Output active when alarm is not triggered	Direct
Latching	<b>Off</b> - Alarm doesn't latch <b>On</b> - Alarm latches (remains in active state until cleared)	Off
LED Indicator	<b>Direct</b> - LED Indicator lit when output is active <b>Reverse</b> - LED Indicator lit when output is inactive	Direct

Parameter	Description	Default Value
<b>Output 2 sub-menu</b>		
Usage	Same options as Output 1 - Usage	Alarm 1
Alarm Action	Same options as Output 1 - Alarm Action	Direct
Latching	Same options as Output 1 - Alarm Latching	Off
LED Indicator	Same options as Output 1 - LED Indicator	Direct
<b>Output 3 sub-menu</b>		
If a Relay or SSR drive is fitted in Output 3, this sub-menu is visible.		
Usage	Same options as Output 1 Usage	Alarm 2
Alarm Action	Same options as Output 1 - Alarm Action	Direct
Alarm Latching	Same options as Output 1 - Alarm Latching	Off
LED Indicator	Same options as Output 1 - LED Indicator	Direct
<b>Linear Outp sub-menu</b>		
If the Linear option is fitted in Output 3, this sub-menu is visible.		
Usage	Heat ( <i>Reverse acting control</i> ) Cool ( <i>Direct acting control</i> ) Retransmission of PV or SP: PV Retx SP Retx	PV Retx
Type	0-10V 2-10V 0-20mA 4-20mA 0-5V 1-5V	0-10V
Scale Range Maximum	Display value at which retransmission output is at its maximum value ( -1999 to 9999)	1000
Scale Range Minimum	Display value at which retransmission output is at its minimum value ( -1999 to 9999)	0

### Control menu for Standard model only

Parameter	Description	Default Value
Proportion Heat Band	The Proportional Bands for heating and cooling control, in display units. Set to ON/OFF (0) or PID control: 1 to 9999 - 0 decimal places 0.1 to 999.9 - 1 decimal place 0.01 to 99.99 - 2 decimal places 0.001 to 9.999 - 3 decimal places Possible values/resolution depends on values display resolution.	161
Proportion Cool Band		161
Auto Reset (Integral)	0.01 to 99.59. and <b>OFF</b> (0.00) (minutes & seconds).	5.00
Overlap/ Deadband	In display units, range -20 to +20% of Heat & Cool Proportional Band	0
Differential (On/Off)	Visible when using On-Off control. In display units centred about the setpoint. Range: 0.1% to 10.0% of input span	8
Loop Alarm Time	Visible when On/Off control & Loop Alarm assigned to an output. Sets time before the loop alarm triggers. (minutes & seconds)	99.59
Manual Rst (Bias)	Manual Reset. Biasing of the control working point, 0 to 100%. (-100% to 100% if heat/cool control)	25%
Heat Cycle Time	0.1 to 512.0 seconds	32.0
Cool Cycle Time	<i>Relay/SSR control output cycle times</i>	32.0
Output Interlock	Prevents simultaneous activation of both heat & cool outputs. Choose from On or Off. Do not use if PB 'overlap' has been set	Off
Heat Power Limit	% heating and cooling power upper limits	100%
Cool Power Limit	0 to 100%	100%
Power Up Action	<b>Last</b> - Powers up with control enable/disable in the same state as on power off or power failure. <b>On</b> - Always powers up with control enabled.	Last



Parameter	Description	Default Value
Automatic Tuning	Off Start Pre-Tune Start Tune at SP ( <i>Not available for Heat &amp; Cool processes.</i> )	Off

### Control menu for Extrusion model only

Parameter	Description	Default Value
Proportion Heat Band	The Proportional Bands for heating and cooling control, in display units. Set to ON/OFF (0) or PID control:  1 to 9999 - 0 decimal places 0.1 to 999.9 - 1 decimal place 0.01 to 99.99 - 2 decimal places 0.001 to 9.999 - 3 decimal places Possible values/resolution depends on values display resolution.	161
Proportion Cool Band		161
Auto Reset (Integral)	0.01 to 99.59. (minutes & seconds) and <b>OFF</b> (0.00).	5.00
Overlap/ Deadband	In display units, range -20 to +20% of Heat & Cool Proportional Band. -ve values=Deadband.	0
Differential (On/Off)	Visible when using On-Off control. In display units centred about the setpoint. Range: 0.1% to 10.0% of input span	8
Loop Alarm Time	Visible with On-Off control & Loop Alarm assigned to an output. Sets time before the loop alarm triggers. (minutes & seconds)	99.59
Manual Rst (Bias)	Manual Reset. Biasing of the control working point, 0 to 100%. (-100% to 100% if heat/cool control)	25%
Soft Start Time	0:01 to 60:00 or <b>OFF</b> (0:00) (minutes & seconds)	OFF
Soft Start Setpoint	The setpoint used by the Soft Start. See Soft Start function section.	-240
Heat Cycle Time	0.1 to 512.0 seconds	32.0
Cool Cycle Time	Relay/SSR control output cycle times	32.0

Parameter	Description	Default Value
Output Interlock	Prevents simultaneous activation of both heat & cool outputs. Choose from <b>On</b> or <b>Off</b> . Do not use if PB 'overlap' has been set	<b>Off</b>
Heat Power Limit	% heating and cooling power upper limits, adjustable from 0 to 100%	<b>100%</b>
Cool Power Limit		<b>100%</b>
Minimum Cooling	Sets the minimum temperature at which water cooling will activate.	<b>120</b>
Impulse Length	Non-linear cooling pulse time. 0.01 to 99.99 (seconds)	<b>10</b>
Minimum Off Time	Minimum non-linear cooling pulse time. 0.01 to 99.99 (seconds)	<b>20</b>
Non Linear Adjust	Attenuates effective cooling vs PID cooling power. From 1 to 999.9	<b>5</b>
Power Up Action	<b>Last</b> - Powers up with control enable/disable in the same state as at power off. <b>On</b> - Always powers up with control enabled.	<b>Last</b>
Automatic Tuning	Off Start Pre-Tune Start Tune at SP ( <i>Not available for dual Heat &amp; Cool</i> )	<b>Off</b>

## Setpoint menu for Standard model only

Refer to Delay, Ramp and Timer diagram.

Parameter	Description	Default Value
Enable Timer	<p><b>Enabled</b> - Enables the Delay and On Timers. Applies at next power-up or next control enable.</p> <p><b>Disabled</b> - Delay and On Timers are ignored. (Setpoint ramping <u>still</u> functions.)</p>	Disabled
Delayed Start Time	Time from power-up or control enable before control begins from 00.01 to 99.59 (hours & minutes) or <b>OFF</b> (0.00). If delay is OFF control starts immediately.	OFF
Ramp Rate	Rate the actual setpoint changes from current PV to target setpoint following power-up or control enable. From 0.001 to 9999 (Units / hr) or OFF (10000). Any changes in the setpoint value also follow this rate.	OFF
On Time	The time the target setpoint will be maintained once reached, from 00.01 to 99.59 (hours & minutes) or Off (00.00) Set to >99.59 for Infinite - control remains on indefinitely.	Infinite
Upper Limit	Used to limit the Maximum setpoint value.	Scale Range Maximum
Lower Limit	Used to limit Minimum setpoint value.	Scale Range Minimum
Offset	<p>For use in multi-zone setpoint slave applications. Offsets the setpoint from -1999 to 9999. Effective SP = SP+Offset. <b>NOTE: effective SP is not limited by setpoint limits.</b></p> <p>'Offset in use' pop-up appears when SP is changed.</p>	0

### Setpoint menu for Extrusion model only

Parameter	Description	Default Value
Ramp Rate	Rate the actual setpoint changes from current PV to target setpoint following power-up or control enable. From 0.001 to 9999 (Units / hr) or OFF (10000). Any changes in the setpoint value also follow this rate.	OFF
Upper Limit	Used to limit the Maximum setpoint value.	Scale Range Maximum
Lower Limit	Used to limit Minimum setpoint value.	Scale Range Minimum
Offset	For use in multi-zone setpoint slave applications. Offsets the setpoint from -1999 to 9999. Effective SP = SP+Offset. <b>NOTE: effective SP is not limited by setpoint limits.</b>  'Offset in use' pop-up appears when SP is changed.	0

### Alarm menu

Applicable to Standard & Extrusion models.

Parameter	Description	Default Value
<b>Alarm 1 sub-menu</b>		
Type	None PV High PV Low Deviation Band	PV High
Value	Value for the alarm, from Range minimum to range maximum, or OFF (maximum +1). OFF disables the alarm.	1373
Hysteresis	Sets the alarm switching differential from 1 display unit to the full input span.	1
<b>Alarm 2 sub-menu</b>		
Type	Same options as Alarm 1 sub-menu.	PV Low
Value		-240
Hysteresis		1

Parameter	Description	Default Value
<b>Options sub-menu</b>		
Alarm Inhibit	Inhibiting of 'active alarms' at power-on, control enable or controller setpoint change. None Alarm 1 Alarm 2 Alarm 1 & 2 (both alarms are inhibited)	None
Alarm Notification	Alternates 'Alarm' with PV value if selected alarm(s) are active. Red alarm output LEDs are not affected by this parameter. None Alarm 1 Alarm 2 Alm. 1and2 (Alarm 1 OR 2)	Alm. 1and2
Sensor Break Alarm	<b>On</b> - activates both alarms, if configured, when a sensor break is detected. If Off, alarms activate only break condition is an alarm condition.	Off

## Communications menu

Applicable to Standard & Extrusion models.

Parameter	Description	Default Value
Unit Address	Modbus address from 1 to 255	1
Baud Rate	Coms data rate in kbps 1200, 2400, 4800, 9600, 19200 & 38400 bps.	9600
Parity	Parity checking: Odd, Even or None	None

## Display menu

Applicable to Standard & Extrusion models.

Parameter	Description	Default Value
Setup Unlock Code	View & adjust Setup lock code. From 1 to 9999 or Off for no lock code.	10
Advanced Unlock Code	View & adjust Advanced lock code. From 1 to 9999 or Off for no lock code.	20
Screen Timeout	Screensaver time. Display turns off after 5, 15 or 30 mins.	5

Parameter	Description	Default Value
Selected language	Choose the display language (English plus one other). From: English & German English & French The second language offered can be changed via the configuration software.	English
Transmitter	'Enable' hides the setpoint, SP.  <b>Important:</b> The device still functions as a controller even though the SP is hidden.	Disable
Reset to Defaults	Used to reset all parameters back to the factory defaults, as shown on the right in parameter lists. See the Default Value column in the Setup and Advanced menu tables.	

## Operator Screens menu

Applicable to Standard & Extrusion models.

Parameter	Description	Default Value
Control Enabled	<b>Hide</b> or <b>Show</b> parameters in Operator Mode. For security, or to simplify the operator screens, hide any that you do not need to allow access to.	Hide
Manual Ctrl Enabled		Hide
Alarm State		Hide
Latch State		Show
Maximum PV		Hide
Minimum PV		Hide
Remaining On Time <i>(Standard model only)</i>		Hide
Remaining Delay Time <i>(Standard model only)</i>		Hide



## Information menu

Applicable to Standard & Extrusion models, read-only menu.

Parameter	Description
PRL	The hardware/software revision level, used for internal quality control.
DOM	The Date of manufacture in mmyy format
FW Version FW Type	Display of the units' firmware version & code type numbers.
Serial	Display of the Serial Number.
Out1 Out2 Out3	Shows the outputs types fitted. These cannot be changed after manufacture. Options are: - <b>SSR</b> (SSR driver) or <b>Relay</b> <b>SSR</b> (SSR driver) or <b>Relay</b> <b>None, SSR</b> (SSR driver), <b>Relay</b> or <b>Linear</b>
Comm DI	Shows other options fitted. These cannot be changed after manufacture. Options are: - RS485 communications - <b>Fitted</b> or <b>None</b> . Digital Input is isolated or not - <b>Iso</b> or <b>NonIs</b>

## Exiting the Advanced Configuration mode

If necessary, press  and  to clear any Pop-Up Alerts.

Press  &  to move up one menu level. Some menus have sub-menus so it may be necessary to press this key combination more than once to exit.

## User Calibration Menu

It is possible to calibrate the controller to compensate for sensor errors etc.

The user calibration menu allows single and 2-point calibration offsets to be applied. The method used will be dependent on the process application. Use two-point calibration to change the calibration slope angle and/or single point to offset all readings by a fixed amount (raising or lowering the calibration slope).



Note: These methods do not alter the internal instrument calibration. Set the offset values back to zero to restore standard measured values. Re-calibration of the internal base calibration is also possible, but should only be attempted by qualified personnel as it overwrites the factory calibration – see Base Input Calibration below.

### Single point calibration (PV Offset)

This is a 'zero offset' applied to the process variable across the entire span. Positive values are added to the reading; negative values are subtracted.

This can be used if the error is constant across the range, or the user is only interested in a single critical value.

To use, select Single Point Calibration from the input calibration menu, and simply enter a value equal, but opposite to the observed error to correct the reading.

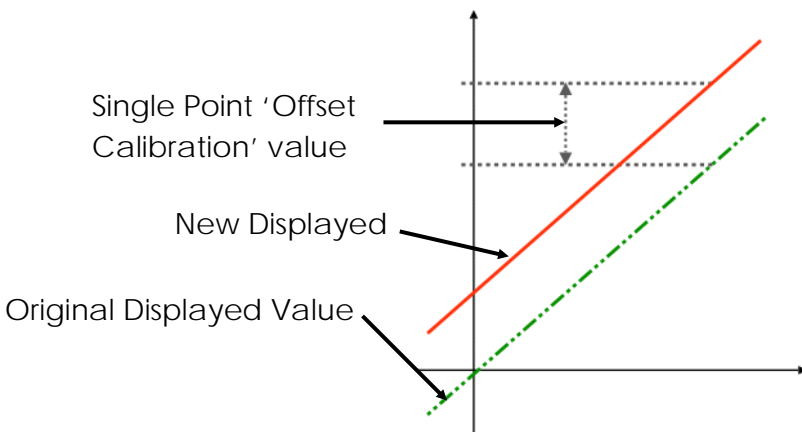

This example shows a positive offset value.

For example:

If the process displays 27.8 when it should read 30, The error is -2.2 so an applied offset of +2.2 would change the displayed value to 30.

The same offset is applied to all values, so at 100.0 the new displayed value would be 102.2 and at 0.0 the new displayed value would be 2.2.



## Two Point Calibration

This method is used where an error is not constant across the range to change the calibration slope. Separate offsets are applied at two points in the range to eliminate both "zero" and "span" errors.

1. Measure and record the error at a low point in the process.
2. Measure and record the error at a high point in the process.
3. Go to the first two-point input calibration screen.
  - a. Enter the desired low point value as the Calibration Low PV value.
  - b. Enter an equal, but opposite value to the observed error as the Calibration Low Offset to correct the error at the low point.
4. Go to the second two-point input calibration screen.
  - a. Enter the desired high point as the Calibration High PV value.
  - b. Enter an equal, but opposite value to the observed error as the Calibration High Offset to correct the error at the high point.

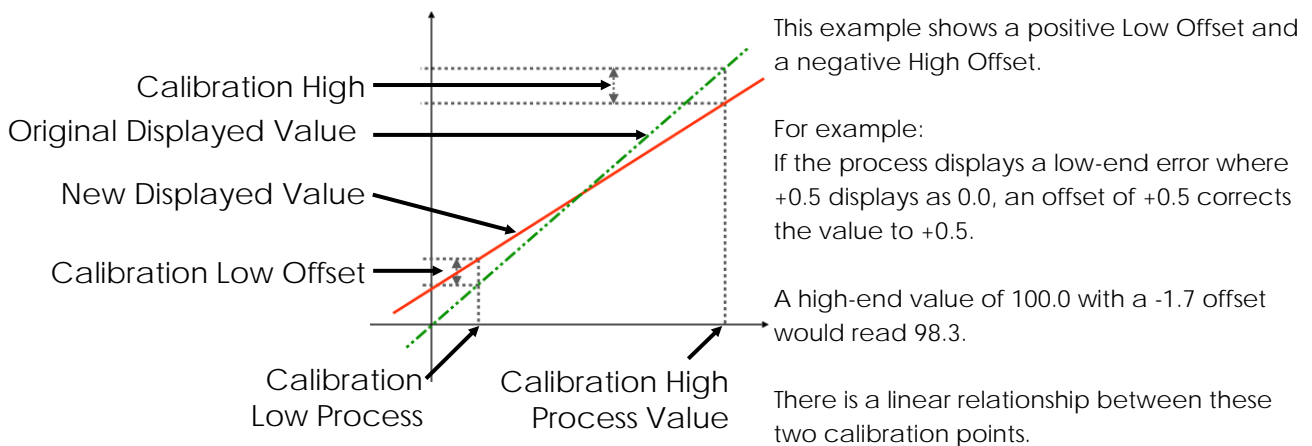

**Important:** Choose values as near as possible to the bottom and top of your usable span to achieve maximum calibration accuracy. The effect of any error can grow at values beyond the chosen calibration points.

The single and two-point calibration methods can be used together, if you need to change the calibration slope and offset the zero point simultaneously.

## Base Input Calibration

Calibration of the input is carried out during manufacture, and for most applications, re-calibration is not required during the lifetime of the instrument. User 1-point and 2-point calibration can be carried from the User Calibration menu.

Re-calibration of the internal base values is possible, but should only be attempted by qualified personnel as it overwrites the factory calibration.

## Equipment Required for Checking or Calibrating the Universal Input

A suitable calibration signal source is required for each input type. To verify the accuracy of the instrument or carry out re-calibration, the input sources listed below are required, with better than  $\pm 0.05\%$  of the reading accuracy:

1. DC linear inputs: 0 to 50mV dc, 0 to 10V dc & 0 to 20mA dc.
2. Thermocouple inputs - complete with 0°C reference facility, appropriate thermocouple functions and compensating leads (or equivalent).
3. RTD inputs: decade resistance box with connections for three-wire input (or equivalent).

## Calibration Check

1. Set up the instrument to the required input type.
2. Note down, then remove any single or two-point calibration values by setting them to zero.
3. Power up the instrument and connect the correct input leads, to the correct terminals.
4. Leave powered up for at least five minutes for RTD and DC linear inputs, or at least 30 minutes for thermocouple inputs.
5. After the appropriate delay for stabilisation has elapsed, check the calibration by connecting the appropriate input source and checking a small number of cardinal points.
6. Repeat the test for all required input types.
7. Check the results against the specification stated for the required input type.
8. Reinstate the calibration values removed at step if they are still appropriate.



Make the connections using the correct thermocouple cable type. For all other input types use copper cable. Using the wrong type of cable will cause incorrect readings. This is especially important with thermocouple sensors.

## Base Calibration Procedure

Input calibration is carried out in five phases as shown below, each phase corresponds to an input range of the instrument.



### Caution:

The 50mV phase must be calibrated first before any other range(s).

Calibration phases:



- i. **mV** for 50 mV
- ii. **V** for 10 V
- iii. **mA** for 20 mA
- iv. **RTD** input (200  $\Omega$  ohm resistance source)
- v. **CJC** (K type thermocouple source at 0°C required)

For Extrusion models phase ii and iii (V & mA) are omitted.







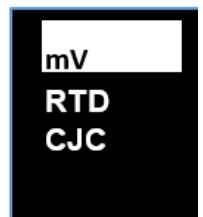

Make the thermocouple connection using the K type thermocouple cable for the CJC calibration phase. For all other phases use copper cable. Using the wrong type of cables will cause incorrect calibration.

## Calibrating the mV Input

1. Check your calibration source is connected to the correct terminals on the MaxVU Rail. For 50mV, connect your mV source +ve to pin 14 and -ve to pin 15 located on the bottom rear connector – see wiring section.
2. Press and hold the  button, whilst the instrument is powering up, until the display shows the screen starting with mV. Be patient, may take approximately 30 seconds.
3. In the calibration phase menu displayed, highlight mV from the list
4. With mV selected, press . The following screen will appear:



>mV Input  
userCAL  
Press enter  
to start



5. Press . You should see the messages **Starting Calibration**, followed by **Calibration in Progress**. A dot moves across the display to show the progress.
6. If the input is wrongly connected or an incorrect signal is applied the calibration will be aborted and the display will show **Calibration FAIL**. The previous calibration value will be retained.
7. If the calibration was successful, the display shows **Calibration PASS**.
8. To clear the Pass or Fail pop-up press  and .
9. Now press  and  to return to the calibration menu. From here either select another calibration phase, or press  and  again to return to the operator screen.

## Calibrating other input types

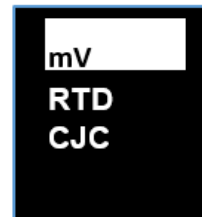
The 50mV calibration must be carried out first. After this, you can select the other types in turn. The other calibration phase procedures are similar to the mV phase above, but ensure that the correct input signal and connections are used – see the wiring section for connection details.



**Note:** When calibrating the RTD input type, connect an accurate 200Ω resistance source across pin 14 and pin 15, and link between pin 13 and pin 14 to replicate the 3-wire compensating lead.

When you have completed the required phases, press  and  to exit back to the operator screen.

The Calibration Mode automatically exits if there is no button activity for five minutes.

### Calibration Input States

Each input can have one of three states:

Description	State Shown
Input not calibrated	noCAL
Factory calibrated	factCAL
User calibrated	userCAL

### Calibration Progress

Description	Popup
Initial popup	Starting calibration .
During calibration	Calibration in progress .
Calibration succeeded	Calibration PASS
Calibration failed	Calibration FAIL

### Calibration Modbus Addresses

The following Modbus addresses can be used to initiate the calibration phases and read back the status.

Description	Comment		Dec	Hex
50mV Calibration	Write 0xCAFE to start the calibration for the selected input.	Write Only	1700	6A4
10V Calibration			1701	6A5
20mA Calibration			1702	6A6
RTD Calibration			1703	6A7
CJC Calibration			1704	6A8
Calibration Status	0x0000 - Calibration Failed 0xCAFE - Calibration Busy 0xFFFF - Calibration Successful	Read Only	1770	6EA

## Automatic Tuning

To avoid process time-lags that can make effective tuning difficult or even impossible, ensure correct sensor and heat source positioning in your application before use.

There are two automatic tuning methods on the MaxVU Rail. Pre-Tune and Tune at SP.

The **Pre-Tune** is a 'start-up disturbance' tuning method. It usually gives better results than **Tune at SP**. However, a minimum 5% of span distance between the process value and setpoint is required for Pre-Tune to run. This means it cannot be used if the setpoint is close to ambient temperature. In this case, use Tune at SP. A full description of Pre-tune and Tune at SP is in the Glossary.



Refer to the Warnings & Messages section for information on the Tuning Error messages.

### Running the Pre-Tune

1. For best results, before running the Pre-Tune adjust the input span (**Scale Range Maximum** and **Scale Range Minimum**) to suit your process, allowing a small tolerance beyond the operating range. e.g. if operating from ambient to 180°C, perhaps set the range 0 to 200.
2. Run from cool. Ideally the process should to be cool before running Pre-Tune. Disable control, or temporarily lower the setpoint, until the PV is a least 5% of the input span difference between the current SP and PV. A larger gap is better if this is possible.
3. Allow for overshoot and undershoot. Please be aware that when the Pre-Tune is run, full power is applied to the process for some time. Although the controller cuts power before the setpoint is reached, some process over/undershoot should be expected. The overshoot might exceed the setpoint value. If exceeding SP might cause a problem, run your first Pre-Tune with a lower SP. If required and safe to do so, you can run another Pre-Tune closer to the required SP.
4. The Pre-Tune can be activated via the **Automatic Tuning** parameter in the Setup menu or the Advanced Configuration menu. It may also be activated via a Modbus command. The message 'TUNE' is displayed whilst Pre-Tune is running. Pre-Tune will not engage, and a Tune Error message will be displayed under the following conditions: **1)**. There is a sensor break, **2)**. The PV is <5% of span from SP, **3)**. A setpoint ramp has been set, **4)**. A Timer is running, **5)**. The current control mode is On-OFF **6)**. The controller is in Manual mode. **7)**. Control is Disabled\*. Resolve the displayed problem then run Tune at SP again if required. **\*Note:** If control is disabled, running Pre-Tune at First Power-up (or immediately after a Reset to Default) automatically sets the control to enabled.
5. Once Pre-Tune is complete it will disengage, and the 'TUNE' notification ends. The length of time the tuning takes to complete will vary from process to process.

## Running Tune at SP

1. Initial PID values. Tune at SP needs a reasonable level of process stability to run. It is therefore recommended to set the initial PID values in the Control menu back to their default values: **Proportional Band** to 10% of your chosen input range, **Auto Reset (Integral)** to 5.00 and **Rate (Derivative)** to 1.15 before using Tune at SP.
2. The Tune at SP can be activated via the **Automatic Tuning** parameter in the Setup menu or the Advanced Configuration menu. It may also be activated via a Modbus command. The message 'TUNE' is displayed whilst Tune at SP is running.
3. Once Tune at SP is complete it will disengage, and the 'TUNE' notification ends. The length of time the tuning takes to complete will vary from process to process

## Tuning at SP Troubleshooting

Tune at SP will not engage, and a Tune Error message will be displayed under the following conditions: **1)**. There is a sensor break, **2)**. A setpoint ramp has been set, **3)**. A Timer is running, **4)**. Control is Disabled. **5)**. The current control mode is On-OFF **6)**. The controller is in Manual mode. Resolve the displayed problem then run Tune at SP again if required.

If Tune at SP starts, but remains running indefinitely, the cause is either the process value not achieving reasonable stability ( $\pm 1\%$  of span), or the control power variation is too great ( $\pm 10\%$ ). To resolve this:

1. Check the PID values in the control menu were at the defaults values (see above). If they were correct, go to step 2. Otherwise, correct them and run Tune at SP again.
2. If step 1 has not resolved the issue, observe the displayed process value for >5minutes and noting the highest and lowest values seen. Subtract the lowest value from the highest to find the peak-to-peak deviation. Check the input span (**Scale Range Maximum** minus the **Scale Range Minimum**) to see if the it is  $>100 \times$  the peak-to-peak deviation. If not, increase the input span to more than this value, and run Tune at SP again.
3. If this has not resolved the issue, double the current PID terms (**Proportional Band**, **Auto Reset** and **Rate** values), then run Tune at SP again.
4. In the unlikely event that the tuning still does not complete continue from step 3.

## Tuning at SP for Heat and Cool

Tuning at SP is possible for Heating or Cooling applications, but not for both Heat and Cool together. If you have defined outputs for heating and cooling, Tune at SP is not offered in the tuning menu. Instead use Pre-Tune.

## Digital Input Operation

Depending on your model, the digital input can be used to perform one of the available functions as shown in the table below.

High = Open contacts (and 2 to 24Vdc for the isolated digital input).

Low = Closed contacts (and <0.8Vdc for the isolated digital input).

Controller Functions	Digital Input State Transition	
	High to Low	Low to High
Reset Latched Alarm(s)	No Action	Reset*
Control Enable/Disable	Disable	Enable
Auto/Manual	Manual	Automatic
Pre-Tune Start/Stop	Stop	Start*
Tune at SP Start/Stop	Stop	Start*

\*Alarm outputs only reset if the alarm condition is no-longer present and tuning will only start if the settings and current process conditions allow (see tuning section for more details)

Limiter Function	Digital Input State Transition	
	High to Low	Low to High
Reset Latched Limit & Alarm(s)	No Action	Reset*

\*Limit and Alarm outputs only reset if the limit exceed and/or alarm conditions are no-longer present.

When the instrument is turned on, a change in the digital input signal from **High Low**, or **Low to High** will cause the function to change (unless it is already in the state dictated by the signal change).

The keypad can also be used to change the status of the same function via the relevant menu. **The most recent digital input or keypad instruction will be implemented.**



**Note:** The digital input is "edge sensitive", which means that it only reacts to a detected transition in the input state. The device cannot detect a status change made when it is turned off. It also means that if it is in the "ON" state, but the current condition of the unit is the "OFF" state (either because a keypad instruction or it has powered up that way) the digital input would first have to be set first to OFF and then ON again before it would set the function ON.

However, on the Limiter model if the Digital Input is in an "ON" state at power-up it gives a Reset signal. Once powered up the Limiter model behaves the same way to a transition.





Below is an illustration of digital input and keypad use. The example is for the Control Enable function. Other functions behave in a similar way.

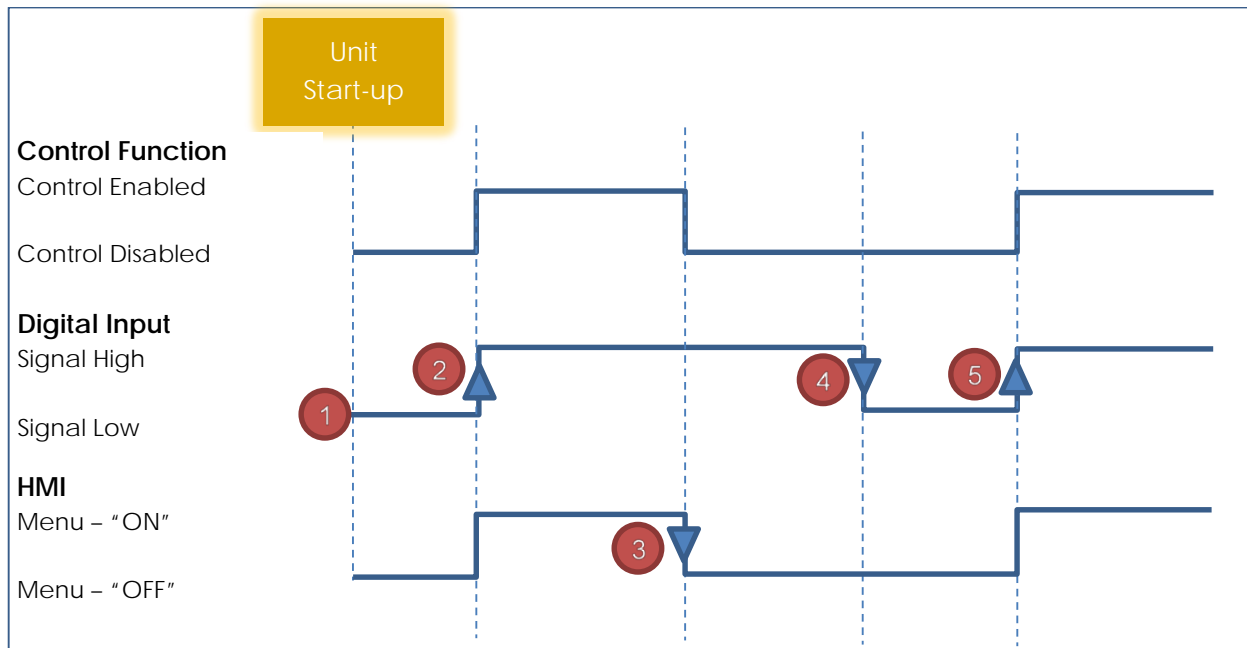

1. On start-up, the unit uses the Power-Up Action for its initial control state. In this example, it starts in the disabled condition.
2. Digital input signal changes from **Low to High**; therefore, control becomes enabled. The **Control Enable** parameter will say **ON**, when viewed from the HMI (front panel).
3. The keypad on the HMI (front panel) menu is used to change the control back to disabled, **Control Enable** parameter = **OFF**.
4. The digital input changes state, going from High to Low, but as the control is already disabled no change is made.
5. Then the digital input goes from Low to High again, re-enabling the control. The **Control Enable** parameter in the HMI also shows control is **ON** again.

## Timer Feature

The timer feature is only available on the Standard model. It consists of a Delay Timer and an On Timer.

When the **Timer Enable** parameter is set to **Disabled** the timer will not be used and the delayed start time and on time are ignored. Note: If the setpoint has been set to ramp, this will still be active, even if the timer is Disabled.

When **Enabled** the timer will take control of the Setpoint as defined by the **Delayed Start Time** and **On Time** parameters. Enabling the timer has no effect until the controller is power cycled or the control is disabled then re-enabled.

The timer, control power down state and the power-up action have the following relationship:

Control state at power down	Power-up Action setting	Timer Enable parameter setting	Delayed Start Value	Control state at power-up
Enabled	Last	Disabled	N/A	Control Enabled
Disabled	Last	Disabled	N/A	Control Disabled
Enabled	On	Disabled	N/A	Control Enabled
Disabled	On	Disabled	N/A	Control Enabled
Enabled	Last	Enabled	Off	Control Enabled
Disabled	Last	Enabled	Off	Control Disabled
Enabled	On	Enabled	Off	Control Enabled
Disabled	On	Enabled	Off	Control Enabled
Enabled	Last	Enabled	Time Set	Control Disabled until Delay timer expires
Disabled	Last	Enabled	Time Set	Control Disabled
Enabled	On	Enabled	Time Set	Control Disabled until Delay timer expires
Disabled	On	Enabled	Time Set	Control Disabled until Delay timer expires

## Delay, Ramp and Timer diagram

The delay, ramp and soak is only available on the standard model.

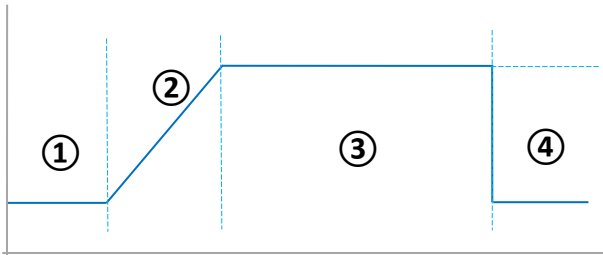

- ① From power-up, if control is in the enabled state, or whenever control is changed from disabled to enabled, the unit delays process control (i.e. control is still disabled) until the Delay Timer expires (time as set by **Delayed Start Time**). If this is OFF, step 1 is omitted.
- ② Setpoint ramps from the current PV to the target setpoint at Ramp Rate ('**RAMP**' alternating with the current effective SP value indicates it is still ramping). If Ramp Rate is **OFF** the effective setpoint steps directly to target setpoint.
- ③ After any Delay and/or Ramp completes, the setpoint 'Dwells' at the target value while the On-Timer counts down (time set by **On Time**).
- ④ When the On Timer finishes the control switches off (i.e. control is disabled). If the On Timer has been set to **OFF**, step 4 is omitted, and control is maintained at the setpoint indefinitely.

## Extrusion Model Only Features

This section applies to the Extrusion version of the MaxVU Rail (models MVRxEx-xxxx-xxxx).

The LED functions on the Extrusion controller are fixed as **Heat**, **Cool** and **Alarm**.

The Non-Linear Cooling and Soft Start Functions are available on the Extrusion version.

### Non-Linear Cooling function

The initial cooling effect with water cooling can be very strong when water first flows into a hot process. Evaporation extracts significant amounts of heat energy making the effective cooling power disproportionately high at nominally low levels of cooling output. This makes process control more difficult, particularly if “over-cooling” during the transition from heating to cooling causes the heating to be re-activated. Non-Linear Cooling can be used to counteract these effects by applying the cooling more gradually at first.

To enable the Non-Linear Cooling function the Output 1, Output 2 or Output 3 **Usage** parameter needs to be set to **Non Linear Cooling**.

>Output 1 Usage	Heat Power Cool Power <span style="background-color: yellow;">Non Linear Cooling</span> Alarm 1 Alarm 2 Alarm 1 or 2 Loop Alarm	Heat Power
--------------------	---	------------

This table lists the Control sub-menu parameters related to non-linear cooling

Title	Description
Minimum Cooling	The minimum temperature for non-linear cooling to operate
Impulse Length	The fixed “On” pulse duration with non-linear cooling
Minimum Off Time	The minimum “Off” duration with non-linear cooling
Non-Linear Adjust	Adaptation of characteristics of the non-linear cooling

### Method

The cooling characteristic is altered so that the controller output is weak until approximately 70% of nominal cooling demand. Beyond this level, the correcting variable rapidly rises to the maximum cooling allowed.

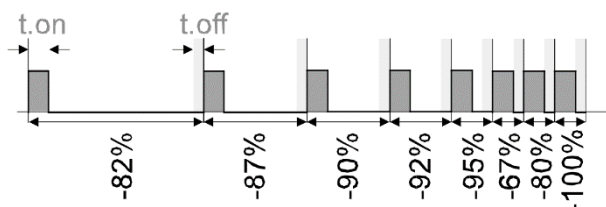

Cooling is inhibited entirely until the Minimum Cooling temperature has been exceeded. After that it turns ON with fixed duration pulses (adjustable with Impulse Length parameter). The OFF time between pulses is varied to adjust the cooling effort, but is never off for less than Minimum Off Time value whenever cooling is active. This ratio limits the maximum effective cooling.

**The maximum effective cooling is calculated as follows:**

$$Max\ Cooling = \frac{Impulse\ Length}{Impulse\ Length + Minimum\ Off\ Time} \times 100\%$$

The Non-Linear Adjust parameter can be reduced if the corrective action is too severe by reducing the non-linearity of the effective output. See the examples below.

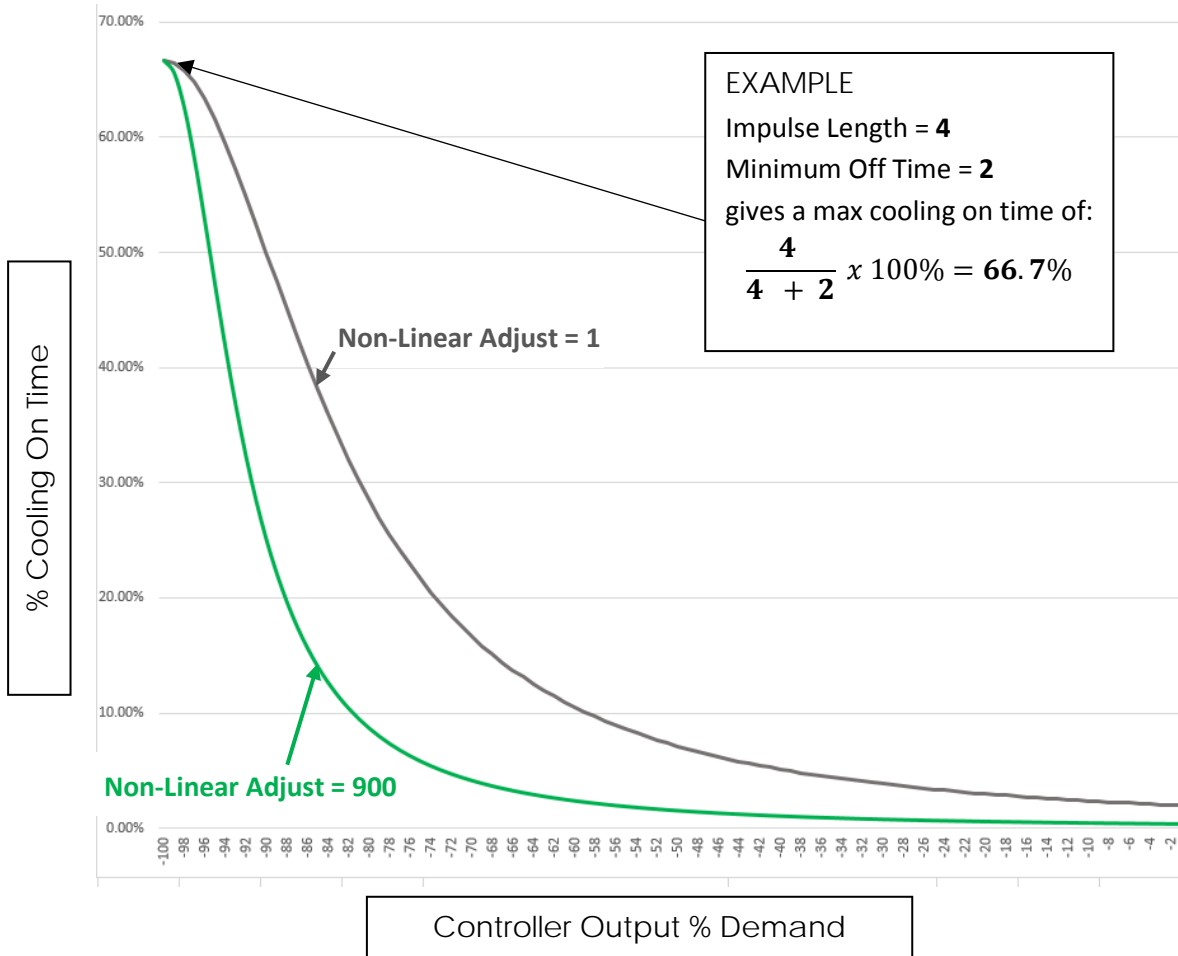

### Parameter Adjustment

#### Minimum Cooling

Cooling is enabled only above the temperature set because evaporation, with its associated cooling effect, is not possible at temperatures below 100°C. Set this >100, but it should be well below the normal operating setpoint.

Note: In manual mode cooling is still possible below this temperature.

## Impulse Length

A fixed length for cooling pulses set by this parameter. The ON pulses are this length for all cooling output values above 1% nominal cooling demand.

Relatively low values should be used, but remember that the ratio of the Minimum Off Time vs Impulse Length affects the maximum effective cooling (see above). Do not allow this to limit cooling to the extent that insufficient cooling effect is available for the process.

The impulse length is also limited by the hardware (e.g. the response time of your valve). Valves and electromechanical relays should not be switched to quickly. Consult the device manual or check with your supplier for suitable minimum settings.

## Minimum Off Time

The "off" time between pulses is varied dependent upon the PID cooling demand. The Minimum Off Time is the minimum allowed "off" time (but note that below 1% of cooling demand, the output is disabled).

The time set is hardware-dependent (e.g. the response time of your valve). Generally, it is best set to the lowest value compatible with the output switching device, but remember that valves and electromechanical relays should not be switched to quickly. Consult the device manual or check with your supplier for suitable minimum settings.

Remember that the ratio of the Minimum Off Time vs Impulse Length affects the maximum effective cooling (see above). Do not allow this to limit cooling to the extent that insufficient cooling effect is available for the process.

## Non-Linear Adjust

This attenuates the cooling curve, and altering where the output rate begins to increase more rapidly. The value can be reduced if the corrective action is too severe, this reduces the non-linearity of the effective output.

To find an appropriate Non-Linear Adjust setting:

First set Minimum Cooling, Impulse Length and Minimum Off Time to appropriate values (see above), and initially set Non-Linear Adjust to 5. Use Pre-Tune or manual tuning to adjust the controllers PID settings to your process.

Using these settings, and observe the transition from heating to cooling. If there is a noticeable over-reaction, where the cooling is still too strong, increase the Non-Linear Adjust value until the effect is reduced to acceptable levels. If the transition becomes too slow, with effective cooling unacceptably delayed, reduce the value set.

## Soft Start function

Soft Start is primarily intended to allow heaters to dry out gradually at start-up - condensation which can form when the heaters are cold can cause damage if it evaporates too quickly. Soft Start has its own setpoint, allowing a pre-defined low-temperature dwell period which reduces the power demand from the heaters – allowing moisture to evaporate more slowly - before going to full working temperature. During this period, it also minimises the heater-on times by reducing the cycle time and limiting the PID power demand.

**Note: Soft Start does not limit the instantaneous current to the heaters when the output is on.**

Activated by setting the parameters **Soft Start Time** and **Soft Start Setpoint**.

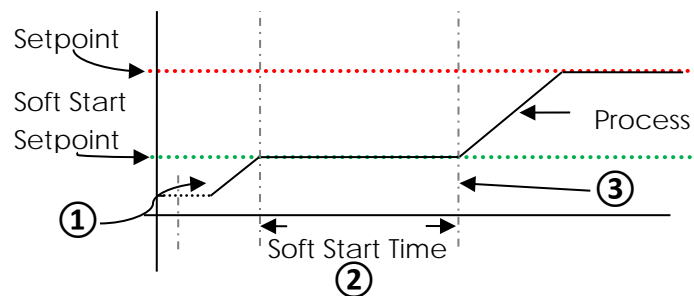

① When powered up the unit will control to the **Soft Start Setpoint**. The control cycle time is  $\frac{1}{4}$  of the value entered (subject to the minimum possible value of 0.5s) and the maximum power demand is limited to the **Heat Power Limit** value (set in the Control menu). The reduced cycle time is used during the soft start phase.

② After reaching the Soft Start Setpoint the Soft Start Time begins. The timer starts as soon as the PV is equal to Soft Start Setpoint - 1. The Soft Start Setpoint is maintained until this time has elapsed.

③ When **Soft Start Timer** expires, the unit returns to normal operation. It controls to the normal setpoint, the cycle time reverts to the value set and the **Heat Power Limit** is no-longer used.



Remember, when using the Soft Start feature the Heat Power Limit is only active from power-on and during the Soft Start Time. It remains in use until the Soft Start timer expires or all the time if no Soft Start time is OFF.



Extrusion Only Parameters in the Control menu

Parameter	Description
Soft Start Time	OFF, 0.01 to 60.0
Soft Start Setpoint	See Soft Start
Heat Cycle Time	0.1 to 512.0
Cool Cycle Time	
Output Interlock	Prevents simultaneous ac and cool outputs
Heat Power Limit	% power upper limit
Cool Power Limit	% power upper limit
Cooling Minimum	Minimum temperature at which cooling is active
Impulse Length	0.01 to 99.9
Minimum Off Time	0.1 to 999.9
Non Linear Adjust	0.1 to 9.9
Power Up Action	Last - Powers up with controller state as on power of On - Always powers up with power
Automatic Tuning	Off Start Pre Start Tune

Soft Start parameters

Non-linear Cooling parameters

## Limiter Models

This section applies to the limiter version of the MaxVU Rail (models MVRxTx-xxxx-xxxx).



### Introduction to the Limiter model

The Limiter model has fixed output functions.

Depending upon which option is fitted in Output 3 it is Alarm 2 or Retransmit PV.

Refer to the Information menu or check the product label identify your version.

Output 1. = **Limit**

Output 2. = **Alarm 1**

Output 3. If Relay or SSR = **Alarm 2** / If Linear = **Retransmit PV**

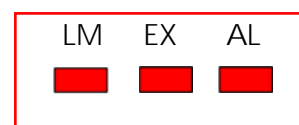
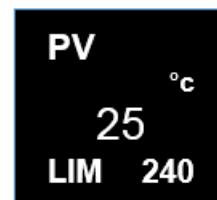

The Limiter LEDs have fixed functions: **Limit, Exceed & Alarm.**

When the PV enters the Exceed condition both the Limit and Exceed LEDs turn ON. Going from the Exceed condition back into the Safe condition the Exceed LED will turn off but the Limit LED will stay latched until it is reset. Remember the Limit output itself is energised in Safe condition but de-energises when in the Limit condition.

Navigating is the same as the Standard and Extrusion versions, see General Navigation & Editing, but for security, users cannot change parameter values such as the Limit Setpoint in the Operator mode on the Limiter model. These can only change values via the lock code protected Setup or Advanced Configuration modes.

Warning & Error messages on the Limiter model are similar to the Standard and Extrusion versions, with the exclusion of control or tuning related messages. On the Limiter, there is the additional pop-up alert **Limit Exceeded** message if the process is beyond the limit value set. Please refer to the Warnings & Messages section.

The Annunciator alarm type, which can be selected for Alarm 1 or Alarm 2, cannot be inhibited.

### Limiter Modbus Communications

Please refer to the Commonly Used Modbus Addresses and the Limiter Modbus Addresses for the Modbus register addresses.











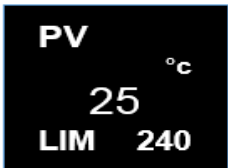

See the Serial Communications for general communications information.

### Limiter Digital Input

The Digital Input has only one function on the Limiter model. There is no need for a configuration parameter because it is always a **Limit & Alarm Reset**. Refer to the Digital Input Operation section.

However, in addition on the Limiter model, if the Digital Input is in an Open state at power-up it gives a Reset signal.

## Limiter Operator Mode & Screens

User Screen		PV – top Temperature & Unit – centre & right. LIM & Limit Setpoint - bottom	
<b>Important:</b> Visibility for parameters below must be set to <b>Show</b> in the <b>Operator</b> menu.			
Alarm State		 Alarm triggered  Alarm set, but not triggered – Alarm not set	
Latch State		To clear press  then  to select <b>Yes</b> .  Press  to accept.	 Output Latched  Latch set, but output not Latched – Latch not set
Maximum PV	To clear press  then  to select <b>Yes</b> .		Screens show the Maximum & Minimum PV reached.
Minimum PV	Press  to accept.		



### Limiter Output Latching

When an SSR drive or Relay output is configured to 'latch' it will remain on after the limit or alarm condition has cleared. The latch enable parameter, **Output Latching**, needs to be **ON** for outputs you want to latch.

### Limiter Clearing Latched Outputs

The latch condition, shown by  in the **Latch State** screen, needs to be cleared either via a Modbus command, digital input or from the front panel.

To clear latches from the front panel, in the Latch State screen, press  then  to select **Yes**.

Press  to accept.



## Limiter Start-up Latch

The parameter **Startup Latch**, is only present on the limiter model. It determines how latching outputs behave when the unit is powered up. It is set individually for each of the outputs (limit and/or the 2 alarms). The three possible modes are as follows:

- **Reset Latch:** The latch state is not remembered when the unit is powered off. The latch becomes active again only if the associated limit / alarm state is present at or after power-on.
- **Always Latch:** The instrument will always power on with the chosen output in the latched state, even if the associated limit or alarm is not active.
- **Last Latch:** The latch state is remembered on power down. Any output that was latched on power down it will still be latched when power is restored, even if that limit or alarm is no-longer active.

**Note:** If a limit or alarm state exists at power-up, previously unlatched outputs always activate immediately, no matter how the Start-up Latch has been set.

## Limiter Sensor Break Detection



If a "Sensor break" is detected on the Limiter model, this always triggers the Limit exceed condition, plaice the process into a safe state. Correct the input problem, then unlatch the limit output to resolve this.

## Limiter Output 3 – Linear, Relay or SSR drive

- If the linear output is fitted to Output 3 on the Limiter model, it can only be used for a PV retransmit function.
- If a relay or SSR drive is fitted in Output 3 then it is fixed as Alarm 2.

## Limiter Setup mode parameters

If necessary, press  &  to enter Setup from Operator mode.

Enter **Setup Lock**-code (default of **10**) using  and , then press .



1. Some parameters may be hidden depending upon configuration & hardware.
2. Note the permissible ranges for each temperature sensor type, below. For example, the B type thermocouple readings cannot have a decimal point, and it cannot measure below 100 °C or above 1824 °C.
3. The number of decimal points is set by the **Decimal Place** parameter.



The parameters are shown in the following table.

Parameter	Description		Default Value
* Maximum of 1 decimal place for temperature inputs, in the green square.			
>Input Type	<b>J Thermocouple *</b>		K Thermocouple
	-200 – 1200°C	-128.8 – 537.7°C	
	-328 – 2192°F	-199.9 – 999.9°F	
	<b>K Thermocouple *</b>		
	-240 – 1373°C	-128.8 – 537.7°C	
	-400 – 2503°F	-199.9 – 999.9°F	
	<b>PT100 *</b>		
	-199 – 800°C	-128.8 – 537.7°C	
	-328 – 1472°F	-199.9 – 999.9°F	
	<b>B Thermocouple</b>		
	100 – 1824°C	211 – 3315°F	
	<b>C Thermocouple</b>		
	0 – 2320°C	32 – 4208°F	
	<b>L Thermocouple *</b>		
0 – 762°C	0.0 – 537.7°C		
32 – 1403°F	32.0 – 999.9°F		
<b>N Thermocouple</b>			
0 – 1399°C	32 – 2551°F		
<b>R Thermocouple</b>			
0 – 1795°C	32 – 3198°F		
<b>S Thermocouple</b>			
0 – 1762°C	32 – 3204°F		
<b>T Thermocouple *</b>			
-240 – 400°C	-128.8 – 400.0°C		

Parameter	Description		Default Value
	-400 – 752°F	-199.9 – 752.0°F	
	<b>Linear dc</b>		
	0 – 20mA	4 – 20mA	
	0 – 50mV	10 – 50mV	
	0 – 5V	1 – 5V	
	0 – 10V	2 – 10V	
>Input Units	°C or °F (not available for Linear dc inputs)		°C
>Input Decimal Place	0000 – no decimal point 000.0 – one decimal point 00.00 – two decimal points ( <i>linear dc only</i> ) 0.000 – three decimal points ( <i>linear dc only</i> )		0000
Scale Range maximum & minimum are only visible when input is a linear dc type.			
>Input Scale Range Maximum	The scaling value for the input range maximum.		1000
>Input Scale Range Minimum	The scaling value for the input range minimum.		0
>Limit Type	<b>High</b> – device will limit when PV is greater than the Limit value. (Exceed condition if PV>Limit Value). <b>Low</b> - device will limit when PV is less than the Limit value. (Exceed condition if PV<Limit value).		High
>Limit Value	The exceed condition value at which the Limit output will trip.		-240
PV Retrans parameters are only visible if Output 3 is Linear.			
> PV Retrans Type	0-10V 2-10V 0-20mA	4-20mA 0-5V 1-5V	0-10V
>PV Retrans Scale Range Maximum	Displayed PV value corresponding to maximum linear output.		1373
> PV Retrans Scale Range Minimum	Displayed PV value corresponding to minimum linear output.		-240
>Alarm 1 Value	Range minimum to range maximum, or OFF (maximum +1) where <b>OFF</b> disables alarm. Default alarm type is <b>PV High</b> .		1373
If a Relay or SSR drive is fitted in Output 3 you will see Alarm 2.			

Parameter	Description	Default Value
>Alarm 2 Value	Same options as Alarm 1. Default alarm type is <b>PV Low</b> .	-240
>Coms Unit Address	Modbus address from 1 to 255	1
>Coms Baud Rate	1200, 2400, 4800, 9600, 19200 & 38400	9600
>Coms Parity	Odd, Even or None	None



If the **Input Type** is changed the relevant values from the table above are used for the **Scale Range Maximum** and **Scale Range Minimum**. Review and change if required.

If necessary, press and to clear any Pop Up Alerts.  
Press & to exit the Setup mode.



## Limiter Advanced Configuration parameters

Sub-menu Name
1. Input
2. User Calibration
3. Outputs
4. Communication
5. Display
6. Information



If necessary, press & to enter Advanced Configuration mode from Operator mode.

Enter **Advanced Lock-code** (default of **20**) using and , then press .

### Limiter - Input Menu

Parameter	Description	Default Value
Input Type	Possible Input types are as listed in the Limiter Setup mode parameters above	K thermocouple
Units	Display Units either °C or °F. <i>This parameter is hidden when input is a linear type and °C or °F are hidden from the display.</i>	°C
Decimal Place	0000 000.0 00.00 ( <i>not for temperature</i> ) 0.000 ( <i>not for temperature</i> )	0000
Scale Range Maximum	The scaling value for the input range maximum.	Maximum allowed for Input Type.
Scale Range Minimum	The scaling value for the input range minimum.	Minimum allowed for Input Type.
Filter Time	<b>OFF</b> or <b>0.5</b> to <b>100.0</b> seconds in <b>0.5</b> increments	<b>2.0</b>

Parameter	Description	Default Value
CJC Enable	<p><b>Enable</b> Enables the internal thermocouple CJC (Cold Junction Compensation).</p> <p><b>Disable</b> Disables the internal CJC. External compensation must be provided for thermocouples.</p>	Enable

 The input scale range, consisting of **Scale Range Maximum** & **Scale Range Minimum** above, is used to narrow the working range (input span) of the controller.

At 5% beyond the scaled range the controller will give over-range or under-range warnings. For example, a range 0 to 100 gives a span of 100c, so when the PV is >105c the display will show **HIGH**.

### Limiters - User Calibration Menu

Parameter	Description	Default Value
Offset	Shifts the input value up or down by a single offset amount across the entire range.	0
Low Point	Enter value at which the low point error was measured.	Lower Limit
Low Offset	Enter equal, but opposite offset value to the observed low point error.	0
High Point	Enter value at which the high point error was measured.	Upper Limit
High Offset	Enter an equal, but opposite offset value to the observed high point error.	0

Please refer to User Calibration Menu

## Limiter - Outputs Menu

Parameter	Description	Default Value
<b>Limit Output</b>		
Type	<p><b>High</b> – device will limit when PV is greater than the Limit value. (Exceed condition if PV&gt;Limit Value).</p> <p><b>Low</b> - device will limit when PV is less than the Limit value. (Exceed condition if PV&lt;Limit value).</p>	High
Value	The exceed condition value at which the Limit output will trip. Adjustable within the Scaled Range set in Input.	-240
Output Latching	<p><b>ON</b> – Limit output latches &amp; needs to be cleared</p> <p><b>OFF</b>- Limit output doesn't latch</p>	ON
Startup latch	<p>Valid only if limit output latching is set to ON</p> <p><b>Reset Latch</b> (resets at power on)</p> <p><b>Always Latch</b> (latches at power on)</p> <p><b>Last Latch</b> (keeps last state at power on)</p>	Last Latch
<b>Alarm 1</b>		
Type	<p>None</p> <p>PV High</p> <p>PV Low</p> <p>Deviation</p> <p>Annunciator</p>	PV High
Value	Adjustable within the Scaled Range set in Input. Range minimum to range maximum, or OFF (maximum +1) where <b>OFF</b> disables alarm.	1373
Hysteresis	Sets the alarm switching differential from 0 to full span, on the "safe" side of the alarm point.	1
Action	<p><b>Direct</b> - Output active when alarm is active.</p> <p><b>Reverse</b> - Output active when alarm is <u>not</u> active.</p>	Direct

Parameter	Description	Default Value
Output Latching	<b>ON</b> – Alarm 1 output latches. Reset to continue <b>OFF</b> – Alarm 1 output doesn't latch	<b>ON</b>
Startup latch	Valid only if Alarm 1 output latching is set to ON <b>Reset Latch</b> (resets at power on) <b>Always Latch</b> (latches at power on) <b>Last Latch</b> (keeps last state at power on)	<b>Last Latch</b>
<b>Alarm 2 menu is only shown if Output 3 is Relay or SSR drive.</b>		
<b>Alarm 2</b>		
Type	None PV High PV Low Deviation Annunciator	<b>PV Low</b>
Value	Adjustable within the Scaled Range set in Input. Range minimum to range maximum, or OFF (maximum +1) where <b>OFF</b> disables alarm.	<b>-240</b>
Hysteresis	Sets the alarm switching differential from 0 to full span, on the "safe" side of the alarm point.	<b>Off</b>
Action	<b>Direct</b> - Output active when alarm is active. <b>Reverse</b> - Output active when alarm <u>not</u> active.	<b>Direct</b>
Output Latching	<b>ON</b> – Alarm 2 output latches. Reset to continue <b>OFF</b> – Alarm 2 output doesn't latch	
Startup latch	Valid only if Alarm 2 output latching is set to ON <b>Reset Latch</b> (resets at power on) <b>Always Latch</b> (latches at power on) <b>Last Latch</b> (keeps last state at power on)	
<b>PV Retrains menu is only shown if Output 3 is Linear.</b>		
<b>PV Retrains</b>		
Output Type	0-10V 2-10V 0-20mA 4-20mA 0-5V 1-5V	<b>0-10V</b>

Parameter	Description	Default Value
Scale Range Maximum	Display value for maximum output -1999 to 9999	1000
Scale Range Minimum	Display value for minimum output -1999 to 9999	0
<b>Alarm Options</b>		
Start-up Inhibit	Inhibit the alarm(s) on Start up :- None Alarm 1 Alarm 2 Alarm 1 & 2	None
Sensor Break	Either <b>OFF</b> or <b>ON</b> . <b>ON</b> - triggers Alarm output(s) when sensor break is detected.	ON

### Limiter - Communications Menu

Parameter	Description	Default Value
Unit Address	Modbus address from 1 to 255	1
Baud Rate	Coms data rate in kbps 1200, 2400, 4800, 9600, 19200 & 38400.	9600
Parity	Parity checking: Odd, Even or None.	None

### Limiter - Display Menu

Parameter	Description	Default Value
Setup Unlock Code	View & adjust Setup mode lock code (password). From 1 to 9999 or Off for no lock code.	10
Advanced Unlock Code	View & adjust Advanced mode lock code (password). From 1 to 9999 or Off for no lock code.	20
Screen Timeout	Screensaver time. Display turns off after 5, 15 or 30 mins.	5
Selected language	Display language – English, German or French.	English
Reset to Defaults	Used to reset all parameters back to the factory defaults. See MaxVU Rail Factory Defaults.	



## Limiter - Information Menu

Parameter	Description
PRL DOM	The hardware/software revision level. Shows the product update status. Date of manufacture in the form of month and year, <b>mmyy</b> .
FW Version FW Type	The firmware version number & code type.
Serial	Serial Number of unit.
Out1 Out2 Out3	Shows factory fitted hardware options – Output 1 can be: <b>SSR</b> (SSR driver) or <b>Relay</b> Output 2 can be: <b>SSR</b> (SSR driver) or <b>Relay</b> Output 3 can be: <b>None</b> , <b>SSR</b> (SSR driver), <b>Relay</b> or <b>Linear</b>
Comm DI	RS485 communications option - <b>Fitted</b> or <b>None</b> . Digital Input is isolated or not - <b>Iso</b> or <b>NonIs</b> – see the Isolation Chart

## Limiter - Exiting from Advanced Configuration mode

If necessary, press  and  to clear any Pop-Up Alerts.

Press  &  to exit up one menu level. Repeat if required.

Some menus have sub-menus so it may be necessary to press this key combination more than once. For example, to go back to the Operator screen from inside the **Output 2** sub-menu you need to go up 3 levels and then press  &  to exit the Advanced Configuration mode.

## MaxVU / MaxVU Rail Configurator PC Software

MaxVU Configurator PC software available to download from [www.west-cs.com](http://www.west-cs.com).

A variant of the Universal Configuration Adaptor is available to connect to the front configuration port on MaxVU and MaxVU Rail. Order code CONV-BA-00-00-00-MV from your supplier.



The software can be used 'offline' to create/edit configuration files for later use. To up/download settings or update firmware your unit must be powered-up, and connected to your PC using the configuration cable/adaptor to the device's configuration port, or a via a working RS485 serial communications link.

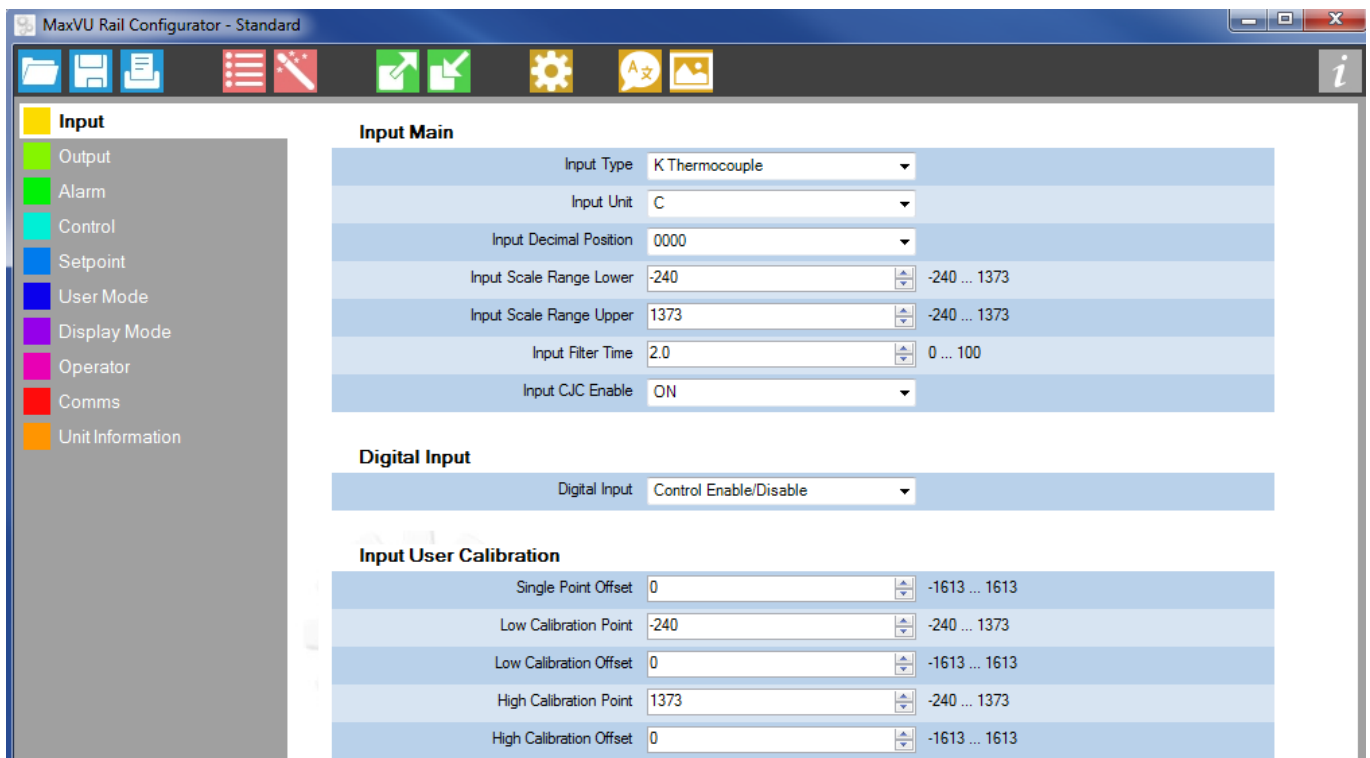

- Specify your hardware – used to define your hardware set up if you are not currently connected to the target instrument. Use if you can't 'Detect Hardware'.



- Wizard – this is a comprehensive wizard to make the setting up process easier.



- Open, Save and Print.



- Read or Write to an instrument.



- Settings.







- Language (MaxVU Rail only).



- Splash screen (MaxVU Rail only).

Select the correct type/model from the list

**Select Device to Load**

-  **MaxVU - Standard**  
Version: 0.1  
Standard MaxVU Temperature Controller device.
-  **MaxVU - Extrusion**  
Version: 0.1  
Extrusion MaxVU Temperature Controller device.
-  **MaxVU - Rail Standard**  
Version: 0.1  
Standard MaxVU Rail Controller.
-  **MaxVU - Rail Limiter**  
Version: 0.1  
Limiter MaxVU Rail Controller.
-  **MaxVU - Rail Extrusion**  
Version: 0.1  
Extrusion MaxVU Rail Controller.



E.g. Select MaxVU Rail Standard then press

### Read in Your Hardware

If you are working online with your instrument,



press **Detect Hardware**, then check and adjust Units' Communication Port, the PC COM port number, and if using RS485, enter the correct Address, Baudrate, Databits and Parity (as currently setup in your instrument).

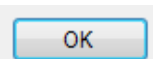

Then press **OK** to read in your MaxVU Rail's hardware options.



This step reads in the hardware settings from the connected unit but not the parameter settings.

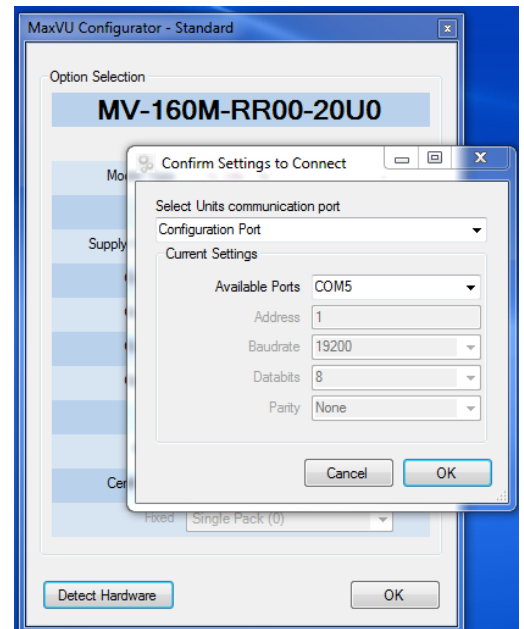



## Read in Parameter Configuration



Before reading in the parameters, first upload the hardware options (see above).



Then press  to read in the current settings from the unit.

## Make Configuration Changes

Edit the configuration to your requirements.

## Write to Unit



Press  to download your new configuration to the unit.

## Save Changes to File



Press  to save any changes to a file if you wish to use it later.

## Firmware and Language Updating

If advised by the factory or your authorised supplier, you can upgrade the firmware in the

connected instrument by pressing . Set the communications parameters (see above), then

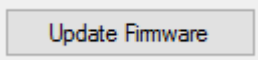
press the  button.

Follow the on-screen instructions, ensuring you select the correct type and version of firmware file (\*.s19) for your MaxVU Rail type.

Model	Firmware Name
Standard	V227E_Encrypt.s19
Extrusion	V227F_Encrypt.s19
Limiter	V227G_Encrypt.s19

If you are uploading language files (MaxVU Rail only) the version needs to match the firmware.

## Serial Communications

### Supported Protocol

The unit supports Modbus RTU protocol through the RS485 interface. For a complete description of the Modbus protocol refer to the description provided at <http://www.modbus.org/>

### RS485 Configuration

The RS485 address, bit rate and character format are configured via the front panel from the Communications Sub-menu.

<b>Data rate:</b>	4800, <b>9600</b> (default), 19200 or 38400 bps
<b>Parity:</b>	<b>None</b> (default), Even or Odd
<b>Device Address:</b>	1 to 255 - See RS485 Device Addressing

The following communication parameters are fixed:

<b>Start bits:</b>	Always 1 bit.
<b>Stop bits:</b>	Always 1 bit.
<b>Character format:</b>	Always 8 bits per character (1 byte).



For successful communication, the master device must have matching communications settings. We do not advise connecting via both the bus connection and the top RS485 at the same time.

When using the PC configuration software via the configuration port, you only need to select the correct PC COM port number. All other parameters are fixed (Device Address=1, Baudrate=19200, Databits=8 and Parity=None).

Select Units communication port	
Configuration Port	
Current Settings	
Available Ports	COM2
Address	1
Baudrate	19200
Databits	8
Parity	None

### RS485 Device Addressing

The instrument must be assigned a unique device address in the range 1 to 255. This address is used to recognise Modbus queries intended for this instrument.

Except for globally addressed broadcast messages sent to device address 0, the instrument ignores Modbus queries from the master that do not match the address that has been assigned to it. These global queries are processed when received but no response messages is returned.

## Link Layer

A Query (or command) is transmitted from the Modbus Master to the Modbus Slave. The slave instrument assembles the reply to the master.

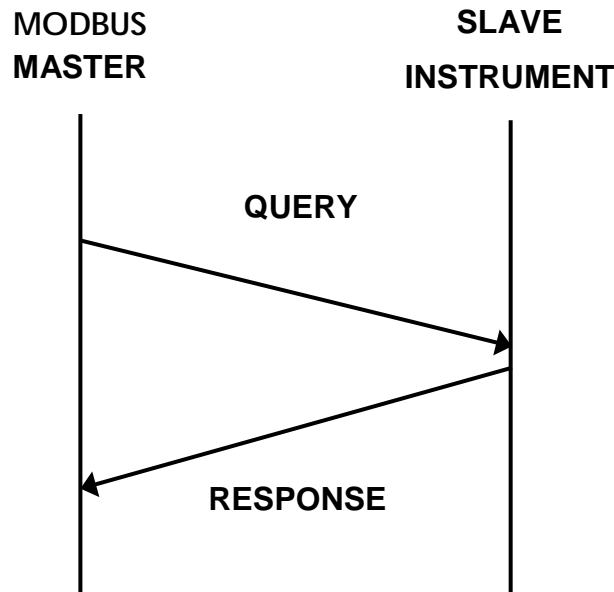

A message for either a QUERY or RESPONSE is made up of an inter-message gap followed by a sequence of data characters. The inter-message gap is at least 3.5 data character times - the transmitter must not start transmission until 3 character times have elapsed since reception of the last character in a message, and must release the transmission line within 3 character times of the last character in a message.



Three character times is approximately 0.75ms at 38400 bps, 1.5ms at 19200 bps, 3ms at 9600 bps and 6ms at 4800bps.

Data is encoded for each character as binary data, transmitted LSB first.

For a QUERY the address field contains the address of the slave destination. The slave address is given together with the Function and Data fields by the Application layer. The CRC is generated from the given address, function and data characters.

For a RESPONSE the address field contains the address of the responding slave. The Function and Data fields are generated by the slave application. The CRC is generated from the address, function and data characters.

The standard MODBUS RTU CRC-16 calculation employing the polynomial  $2^{16}+2^{15}+2^2+1$  is used.

Inter-message gap	Address 1 character	Function 1 character	Data <i>n</i> characters	CRC Check 2 characters
-------------------	------------------------	-------------------------	-----------------------------	---------------------------

## Supported Modbus Functions

The following Modbus function types are supported by this instrument:

Function Code decimal (hexadecimal)	Modbus Meaning	Description
03 (0x03) 04 (0x04)	Read Holding Registers Read Input Registers	Read current binary value of specified number of parameters at given address. Up to 64 parameters can be accessed with one query.
06 (0x06)	Write Single Holding Register	Writes 2 bytes to a specified word address.
08 (0x08)	Diagnostics	Used for loopback test only to check the communications work.
16 (0x10)	Write Multiple Holding Registers	Writes up to 253 bytes of data to the specified address range.

### Function Descriptions

The following is interpreted from the Modbus Protocol Description obtainable from <http://www.modbus.org/>.

In the function descriptions below, the preceding device address value is assumed, as is the correctly formed two-byte CRC value at the end of the QUERY and RESPONSE frames.

#### Function 03 / 04 - Read Holding/Input Registers

Reads the current binary value of data at the specified word addresses.

QUERY

Function	Address of 1 <sup>st</sup> Word		Number of Words	
03 / 04	HI	LO	HI	LO

RESPONSE

Function	Number of Bytes	First Word		Last Word	
03 / 04	n	HI	LO	HI	LO

In the response, the "Number of Bytes" 'n', indicates the number of data bytes read from the instrument. E.g. if 5 words are read, the count will be 10 (A hex). The maximum number of words that can be read is 64. If a parameter does not exist at one of the addresses read, then a value of 0000h is returned for that word.

### Function 06 – Write Single Register

QUERY

Function	Diagnostic Code		Value	
06	HI =00	LO=00	HI	LO

RESPONSE

Function	Sub-function		Value	
06	HI=00	LO=00	HI	LO

### Function 08 - Loopback Diagnostic Test

QUERY

Function	Diagnostic Code		Value	
08	HI =00	LO=00	HI	LO

RESPONSE

Function	Sub-function		Value	
08	HI=00	LO=00	HI	LO



The Response normally returns the same data as the loopback query itself and so can be used to test the communications. Other Diagnostic Codes are not supported.

### Function 16 (0x10 Hex) - Write Multiple Registers

Writes consecutive word (two-byte) values starting at the specified address.

QUERY

Function	1 <sup>st</sup> Write Address		Number of Words to Write		Number of Query Bytes		1 <sup>st</sup> Query Byte	2 <sup>nd</sup> Query Byte	etc	Last Query Byte
10	HI	LO	HI	LO					→	

RESPONSE

Function	1 <sup>st</sup> Word Address		Number of Words	
10	HI	LO	HI	LO



The number of data bytes that can be written in one message is 253 bytes.

## Modbus Addresses

Register addresses are given in Decimal and Hexadecimal formats.

Parameter access can be Read Only (RO), Write Only (WO) or Read & Write (R/W)

### Commonly Used Modbus Addresses

Name	Dec	Hex	Access	Comments
Process Variable	1070	42E	RO	Read process variable value
Actual Setpoint	1270	4F6	RO	Actual effective setpoint (e.g. instantaneous value when setpoint in ramping). Not applicable for limiter
Setpoint	1200	4B0	R/W	Target controller Setpoint, settable within setpoint upper/lower limit values. Not applicable for limiter
Limit Value	1481	5C9	R/W	The 'Exceed' value at which the limit output will trip. Settable within the input range. Limiter only.
Limit Exceed Status	1492	5D4	RO	0 = Limit value not exceeded, 1 = Limit value exceeded
Alarm 1 Value	1402	57A	R/W	Alarm 1 value. Limited by the input span
Alarm 2 Value	1406	57E	R/W	Alarm 2 value. Limited by the input span
Alarm 1 Status	1470	5BE	RO	0 = Alarm 1 inactive, 1 = Alarm 1 active
Alarm 2 Status	1471	5BF	RO	0 = Alarm 2 inactive, 1 = Alarm 2 active
Output Latch Status	1170	47F	RO	A bit mask where bit 1 = Output 1 latched, bit 2 = Output 2 latched, bit 3 = Output 3 latched. E.g. binary 00000101 = outputs 1 & 3 are latched
Latch Reset	1151	492	WO	1 = Attempts to reset all latched outputs (effect is subject to process conditions)
Sensor Break Status	1072	430	RO	0 = Ok, 1 = Sensor Break
Control Enable/Disable	1375	55F	R/W	0 = Control Disabled, 1 = Control Enabled Not applicable to Limiter model
Control Enable State	1376	560	RO	0 = Control Disabled, 1 = Control Enabled Not applicable to Limiter model
Manual Power Enable	1315	523	R/W	0 = Automatic Control, 1 = Manual Control Not applicable to Limiter model.
Combined Power (Manual Power in Manal Mode)	1316	524	RO/RW	A read only combined heat/cool power level in automatic mode, or used to write the power level in manual mode. -100 (max cooling) to 100 (max heating) Not applicable to Limiter model.
Heat Power Output (Primary)	1370	55A	RO	0-100% heating/primary power. Not applicable on Limiter
Cool Power Output (Secondary)	1371	55B	RO	0-100% cooling/secondary power. Not applicable on Limiter
Automatic Tuning	1384	568	R/W	Read: 0 = Inactive, 1 = PreTune Active 2 = Tune at SP Active Write: 0 = Stop Tune, 1 = Run PreTune 2 = Run Tune at SP

## Standard and Extrusion Modbus Addresses

Name	HMI Mode	Dec	Hex	Access	Comments
Process Variable	Operator/User	<b>1070</b>	42E	RO	Read process variable value
Sensor Break Status	Operator/User	<b>1072</b>	430	RO	0 = Ok, 1 = Sensor Break.
Digital Input Status	Operator/User	<b>1075</b>	433	RO	0 = Off, 1 = On
Alarm 1 Status	Operator/User	<b>1470</b>	5BE	RO	0 = Alarm 1 inactive, 1 = Alarm 1 active
Alarm 2 Status	Operator/User	<b>1471</b>	5BF	RO	0 = Alarm 2 inactive, 1 = Alarm 2 active
Latch Reset	Operator/User	<b>1151</b>	492	WO	1 = Attempts to reset all latched outputs (effect is subject to process conditions)
Output Latch Status	Operator/User	<b>1170</b>	47F	RO	A bit mask where bit 1 = Output 1 latched, bit 2 = Output 2 latched, bit 3 = Output 3 latched. E.g. binary 00000101 = outputs 1 & 3 are latched
Output 1 Latch Status	Operator/User	<b>1171</b>	47F	RO	0 = Output 1 not latched, 1 = latched
Output 2 Latch Status	Operator/User	<b>1172</b>	47F	RO	0 = Output 2 not latched, 2 = latched
Output 3 Latch Status	Operator/User	<b>1173</b>	47F	RO	0 = Output 3 not latched, 3 = latched
Output 1 Status	Operator/User	<b>1175</b>	47F	RO	0 = Output 1 OFF, 1 = ON
Output 2 Status	Operator/User	<b>1178</b>	47F	RO	0 = Output 2 OFF, 1 = ON
Output 3 Status	Operator/User	<b>1181</b>	47F	RO	0 = Output 3 OFF, 1 = ON
Actual Setpoint	Operator/User	<b>1270</b>	4F6	RO	Actual effective setpoint (e.g. instantaneous value when setpoint in ramping). Not applicable for limiter,
Manual Power Enable	Operator/User	<b>1315</b>	523	R/W	0 = Automatic, 1 = Manual Control
Combined Power (or Manual mode power value)	Operator/User	<b>1316</b>	524	RO (RW)	A read only combined heat/cool power level in automatic mode (or used to write the power level in manual mode). -100 (max cooling) to 100 (max heating) Not applicable to Limiter model.
Heat Power Output (Primary)	Operator/User	<b>1370</b>	55A	RO	0-100% heating/primary power. Not applicable on Limiter
Cool Power Output (Secondary)	Operator/User	<b>1371</b>	55B	RO	0-100% cooling/secondary power. Not applicable on Limiter

Name	HMI Mode	Dec	Hex	Access	Comments
Control Enable/Disable	Operator/User	<b>1375</b>	55F	R/W	0 = Control Disable, 1 = Control Enable
Control Enable State	Operator/User	<b>1376</b>	560	RO	0 = Control Disabled, 1 = Control Enabled
Digital Input Function	Input	<b>1007</b>	3EF	R/W	Sets the function digital input controls: 0 - No Action (Default) 1 - Alarm Reset (High) 2 - Control Enable (High) / Disable (Low) 3 - Control Auto (High) / Manual (Low) 4 - Pre-tune Stop (High) / Start (Low) 5 - Tune at SP Stop (High) / Start (Low)
Cold Junction Compensation	Input	<b>1006</b>	3EE	R/W	0 = Cold Junction Disabled, 1 = Enabled
Filter Time	Input	<b>1004</b>	3EC	R/W	0 (OFF) or 5 to 1000 = Input filter time OFF or 0.5 to 100.0 seconds, in 0.5s increments
Scale Range Lower Limit	Input	<b>1002</b>	3EA	R/W	Max working temperature, or display value for the max linear input level
Scale Range Upper Limit	Input	<b>1001</b>	3E9	R/W	Min working temperature, or display value for the min linear input level
Decimal Point Position	Input	<b>1003</b>	3EB	R/W	The number of decimal places displayed: 0 - XXXX 1 - XXX.X 2 - XX.XX (linear inputs only) 3 - X.XXX (linear inputs only)
Input Units	Input	<b>1005</b>	3ED	R/W	0 = Deg C, 1 = Deg F



Name	HMI Mode	Dec	Hex	Access	Comments	
Input Type	Input	1000	3E8	R/W	Value	Range
					0	J Thermocouple
					1	K Thermocouple
					2	PT100
					3	B Thermocouple
					4	C Thermocouple
					5	L Thermocouple
					6	N Thermocouple
					7	R Thermocouple
					8	S Thermocouple
					9	T Thermocouple
					10	0 – 20mA
					11	4 – 20mA
					12	0 – 50mA
					13	10 – 50mA
					14	0 – 5V
					15	1 – 5V
					16	0 – 10V
17	2 – 10V					
User High Calibration Offset	User Calibration	1605	645	R/W	The required adjustment +/- Span	
User High Calibration Point	User Calibration	1604	644	R/W	The adjustment point: Input range maximum to input range minimum	
User Low Calibration Offset	User Calibration	1603	643	R/W	The required adjustment +/- Span	
User Low Calibration Point	User Calibration	1602	642	R/W	The adjustment point: Input range maximum to input range minimum	
User Single Point Offset	User Calibration	1601	641	R/W	The required adjustment +/- Span	
Linear Output 3 Type	Outputs	1140	474	R/W	Possible types. Valid if linear output fitted. 1 = 0-10V 2 = 2-10V 3 = 0-20mA 4 = 4-20mA 0 = 0-5V 5 = 1-5V	
Linear Out 3 Scale Maximum	Outputs	1141	475	R/W	PV or SP value where retransmit output is at min level (e.g. 4mA if type is 4-20). Adjustable from -1999 to 9999	
Linear Out 3 Scale Minimum	Outputs	1142	476	R/W	PV or SP value where retransmit output is at max level (e.g. 20mA if type is 4-20). Adjustable from -1999 to 9999	

Name	HMI Mode	Dec	Hex	Access	Comments
Output 3 Usage	Outputs	<b>1130</b>	46A	R/W	<p>If Relay/SSR fitted:            0 = Heat Output            1 = Cool Output            2 = Non-Linear Cooling – <i>Only Extrusion</i>            3 = Alarm 1            4 = Alarm 2            5 = Alarm 1 or Alarm 2            6 = Loop Alarm</p> <p>If Linear out fitted:            0 = Heat Output            1 = Cool Output            7 = Retransmit Setpoint            8 = Retransmit Process value</p>
Output 3 Indicator Invert	Outputs	<b>1131</b>	46B	R/W	0 = Sync with output, 1 = Opposite to output (e.g. ON when output off)
Output 3 Alarm Latching	Outputs	<b>1133</b>	46D	R/W	0 = Off, 1 = On (will latch on when active)
Output 3 Alarm Action	Outputs	<b>1132</b>	46C	R/W	0 = Direct, 1 = Reverse (off if alarm active)
Output 2 Indicator Invert	Outputs	<b>1121</b>	461	R/W	0 = Sync with output, 1 = Opposite to output (e.g. ON when output off)
Output 2 Alarm Latching	Outputs	<b>1123</b>	463	R/W	0 = Off, 1 = On (will latch on when active)
Output 2 Alarm Action	Outputs	<b>1122</b>	462	R/W	0 = Direct, 1 = Reverse (off if alarm active)
Output 2 Usage	Outputs	<b>1120</b>	460	R/W	<p>0 = Heat Output            1 = Cool Output            2 = Non-Linear Cooling – <i>Only Extrusion</i>            3 = Alarm 1            4 = Alarm 2            5 = Alarm 1 or Alarm 2            6 = Loop Alarm</p>
Output 1 Indicator Invert	Outputs	<b>1101</b>	44D	R/W	0 = Sync with output, 1 = Opposite to output (e.g. ON when output off)
Output 1 Alarm Latching	Outputs	<b>1103</b>	44F	R/W	0 = Off, 1 = On (will latch on when active)
Output 1 Alarm Action	Outputs	<b>1102</b>	44E	R/W	0 = Direct, 1 = Reverse (off if alarm active)
Output 1 Usage	Outputs	<b>1100</b>	44C	R/W	<p>0 = Heat Output            1 = Cool Output            2 = Non-Linear Cooling – <i>Only Extrusion</i>            3 = Alarm 1            4 = Alarm 2            5 = Alarm 1 or Alarm 2            6 = Loop Alarm</p>

Name	HMI Mode	Dec	Hex	Access	Comments
Automatic Tuning	Control	<b>1384</b>	568	R/W	Read: 0 = Inactive, 1 = PreTune Active 2 = Tune at SP Active Write: 0 = Stop Tune, 1 = Run PreTune 2 = Run Tune at SP
Tune Status / Error Messages	Control	<b>1378</b>	562	RO	0= No tuning active 1= Tuning active 2= PV within 5% of setpoint 3= Setpoint is Ramping 4= Control On/Off 5= Manual Control 6= Pulse Tune Error 7= Sensor Break 8= Timer running 9= Control disabled 10= Setup not completed
Power Up Action	Control	<b>1377</b>	561	R/W	On power-up control enable/disable is: 0=Last State, 1=Always Enabled
Cool Power Limit	Control	<b>1312</b>	520	R/W	Sets limit from 0-100% cooling
Heat Power Limit	Control	<b>1311</b>	51F	R/W	Sets limit from 0-100% Heating
Output Interlock	Control	<b>1185</b>	4A1	R/W	0=Interlock Off or 1=Interlock On (On prevents simultaneous heating & cooling) Do not use if PB 'overlap' has been set
Cool Cycle Time	Control	<b>1318</b>	526	R/W	0 (OFF) or 1 to 5120 = Cycle time OFF or 0.1 to 512.0 seconds, in 0.1s increments
Heat Cycle Time	Control	<b>1317</b>	525	R/W	0 (OFF) or 1 to 5120 = Cycle time OFF or 0.1 to 512.0 seconds, in 0.1s increments
Bias (Manual Reset)	Control	<b>1307</b>	51B	R/W	Biases the working point 0% to 100% or -100 to +100% for dual control
On/Off Differential	Control	<b>1308</b>	51C	R/W	0.1% to 10.0% of input span
Overlap/Deadband	Control	<b>1306</b>	51A	R/W	In display unit, values from -20% to 20% of combined primary and secondary proportional band values
Loop Alarm Time	Control	<b>1310</b>	51E	R/W	1- 5999 seconds (used in manual mode if loop alarm has been configured)
Derivative Time (Rate)	Control	<b>1305</b>	519	R/W	0 (Off) or 1 to 5999 seconds
Integral Time (Automatic Reset)	Control	<b>1304</b>	518	R/W	0 (Off) or 1 to 5999 seconds
Cool Proportional Band	Control	<b>1303</b>	517	R/W	0 = On/Off control, or 1 to 9999 cooling band, in display units (e.g. = 0.001 to 9.999 if display has 3 decimal places)
Heat Proportional Band	Control	<b>1302</b>	516	R/W	0 = On/Off control, or 1 to 9999 heating band, in display units (e.g. = 0.001 to 9.999 if display has 3 decimal places)

Name	HMI Mode	Dec	Hex	Access	Comments
Soft Start Setpoint	Control	<b>1290</b>	50A	R/W	Setpoint during Soft Start. Settable within setpoint upper/lower limit values. Extrusion model only
Soft Start Time	Control	<b>1291</b>	50B	R/W	0 = Soft Start Off, or 1 to 3600 seconds' duration. Extrusion model only
Soft Start Time Remaining	Control	<b>1292</b>	50C	RO	Extrusion model only
Soft Start Time Remaining Secs	Control	<b>1293</b>	50D	RO	Extrusion model only
Soft Start Time Remaining = ( Soft Start Time Remaining – 1) + Soft Start Time Remaining Secs)					
Setpoint Offset	Setpoint	<b>1205</b>	4B5	R/W	Offset the entered SP by -1999 to 9999 Effective SP = SP+Offset. <b>NOTE: effective SP is not limited by the setpoint limits.</b>
Setpoint	Setpoint	<b>1200</b>	4B0	R/W	Target controller Setpoint value, settable within setpoint upper/lower limit values
Setpoint Lower Limit	Setpoint	<b>1202</b>	4B2	R/W	Minimum value for target Setpoint. Adjustable within scale range. <b>NOTE: does not limit effective SP with 'Offset'</b>
Setpoint Upper Limit	Setpoint	<b>1201</b>	4B1	R/W	Maximum value for target Setpoint. Adjustable within scale range. <b>NOTE: does not limit effective SP with 'Offset'</b>
Timer On-Time	Setpoint	<b>1277</b>	4FD	R/W	Time the setpoint is maintained (the 'dwell' after any delay or ramp). Set 1 to 5999 minutes, 0 = No Dwell. Control is disabled when Dwell ends. 6000 = Infinite Dwell. Standard controller model only.
Setpoint Ramp Rate	Setpoint	<b>1204</b>	4B4	R/W	The rate from 1 to 9999 display units for 'ramping' the setpoint. 10000 = Off (SP steps straight to the target value)
Delayed Start Time Value	Setpoint	<b>1276</b>	4FC	R/W	Time from power-up or control enable before control actually begins. Set 1 to 5999 minutes, 0 = No Delay.
Timer Enable	Setpoint	<b>1275</b>	4FB	R/W	0 = Delay & On-Timer disabled, 1 = Enabled. Standard model only
Sensor Break Activate Alarm	Alarms	<b>1409</b>	581	R/W	0 = Off, 1 = Detected break <u>always</u> activates both alarms (if configured). If Off, alarms only activate if break condition is also an alarm condition.

Name	HMI Mode	Dec	Hex	Access	Comments
Alarm Notification	Alarms	<b>1408</b>	580	R/W	While display is active, this alternates 'Alarm' with PV value if selected alarm(s) are active. Red alarm output LEDs are not affected. 0 = None, 1 = Alarm 1, 2 = Alarm 2, 3 = Alarm 1 or Alarm 2
Alarm Inhibit	Alarms	<b>1410</b>	582	R/W	Set alarms to Inhibit at power-up or controller setpoint change. 0 = None, 1 = Alarm 1, 2 = Alarm 2 3 = Both Alarms
Alarm 2 Hysteresis	Alarms	<b>1407</b>	57F	R/W	Alarm 2 switching hysteresis. Limited by the input span
Alarm 2 Value	Alarms	<b>1406</b>	57E	R/W	Alarm 2 value. Limited by the input span
Alarm 2 Type	Alarms	<b>1404</b>	57C	R/W	0 = None (alarm not used) 1 = High Alarm 2 = Low Alarm 3 = Deviation 4 = Band Alarm
Alarm 1 Hysteresis	Alarms	<b>1403</b>	57B	R/W	Alarm 1 switching hysteresis. Limited by the input span
Alarm 1 Value	Alarms	<b>1402</b>	57A	R/W	Alarm 1 value. Limited by the input span
Alarm 1 Type	Alarms	<b>1400</b>	578	R/W	0 = None (alarm not used) 1 = High Alarm 2 = Low Alarm 3 = Deviation 4 = Band Alarm
Parity	Communications	<b>1501</b>	5DD	R/W	0 = None, 1 = Even, 2 = Odd
Baud Rate	Communications	<b>1502</b>	5DE	R/W	0 = 1200 bps 1 = 2400 bps 2 = 4800 bps 3 = 9600 bps 4 = 19200 bps 5 = 38400 bps
Modbus Address	Communications	<b>1500</b>	5DC	R/W	Unique instrument network address from 1 to 255
Selected Language	Display	<b>1828</b>	724	R/W	Language selection. 0 = English, 1 = The installed alternative language
Alternative Language	Display	<b>1808</b>	710	RO	The Installed alternative language. 00 = German, 01 = English, 02 = French
Screen Timeout	Display	<b>1830</b>	726	R/W	0 = 5mins, 1 = 15mins & 2 = 30mins without keypress before timeout
Transmitter View Enable	Display	<b>1806</b>	70E	R/W	0 = Off, 1 = Hide setpoint on display, but control functions are still active.

Name	HMI Mode	Dec	Hex	Access	Comments
Advanced Lock Code	Display	<b>1803</b>	70B	R/W	The password to enter the Advanced Menu 0 = Off, or 1 to 9999
Setup Lock Code	Display	<b>1804</b>	70C	R/W	The password to enter the Setup Menu 0 = Off, or 1 to 9999
Unhide Delay Time Remaining	Operator	<b>2207</b>	89F	R/W	0 = Hide, 1 = Show remaining time
Unhide Time On Remaining	Operator	<b>2206</b>	89E	R/W	0 = Hide, 1 = Show remaining time
Unhide Manual Control Enable	Operator	<b>2205</b>	89D	R/W	0 = Hide, 1 = Show auto/manual select
Unhide Control Enable	Operator	<b>2204</b>	89C	R/W	0 = Hide, 1 = Show control enable/disable
Unhide Alarm Status	Operator	<b>2203</b>	89B	R/W	0 = Hide, 1 = Show alarm status
Unhide Alarm Latch	Operator	<b>2202</b>	89A	R/W	0 = Hide, 1 = Show alarm latch screen
Unhide PV Min	Operator	<b>2201</b>	899	R/W	0 = Hide, 1 = Show stored minimum PV
Unhide PV Max	Operator	<b>2200</b>	898	R/W	0 = Hide, 1 = Show stored maximum PV
Date Of Manufacture	Information	<b>505</b>	1F9	RO	Encoding e.g. 0403 for April 2003 is returned as 193 hex.
<b>Serial Number</b> formed of aaaa bbbb cccc (12 BDC digits):					
Serial Number High	Information	<b>504</b>	1F8	RO	First four digits, aaaa, bits 32-47
Serial Number Mid	Information	<b>503</b>	1F7	RO	Middle four digits, bbbb, bits 16-31
Serial Number Low	Information	<b>502</b>	1F6	RO	Last four digits, cccc, bits 0-15
PRL	Information	<b>506</b>	1FA	RO	Formatted as high byte hardware number as integer [0-99], low byte ascii character [A-Z] for software
Firmware Type Low	Information	<b>65451</b>	FFAB	RO	(e.g. 227E). Returned as ascii
Firmware Type High	Information	<b>65450</b>	FFAA	RO	(e.g. 227E). Returned as ascii
Firmware Version High	Information	<b>65458</b>	FFB2	RO	(e.g. 10p12). Returned as ascii
Firmware Version Mid	Information	<b>65457</b>	FFB1	RO	(e.g. 10p12). Returned as ascii
Firmware Version Low Mid	Information	<b>65456</b>	FFB0	RO	(e.g. 10p12). Returned as ascii
Firmware Version Low	Information	<b>65455</b>	FFAF	RO	(e.g. 10p12). Returned as ascii
Communications Option (RS485)	Information	<b>603</b>	25B	RO	0 = Not Fitted, 1 = Fitted.
Option 3	Information	<b>602</b>	25A	RO	0= None, 1= Relay, 5= Linear
Option 2	Information	<b>601</b>	259	RO	0= None, 1= Relay, 3= SSR
Option 1	Information	<b>600</b>	258	RO	0= None, 1= Relay, 3= SSR
Supply Voltage	Information	<b>511</b>	1FF	RO	0= 240V, 1= Low Voltage
Variant	Information	<b>510</b>	1FE	RO	1= Standard, 0= Extrusion, 2= Limit
Digital Input	Information	<b>509</b>	1FD	RO	0= Non-isolated, 1= Isolated.

## Limiter Modbus Addresses

Name	HMI Mode	Dec	Hex	Access	Comments
Process Variable	Operator/User	<b>1070</b>	42E	RO	Read process variable value
Sensor Break Status	Operator/User	<b>1072</b>	430	RO	0 = Ok, 1 = Sensor Break.
Limit Exceed Status	Operator/User	<b>1492</b>	5D4	RO	0 = Limit value not exceeded, 1 = Limit value exceeded
Alarm 1 Status	Operator/User	<b>1470</b>	5BE	RO	0 = Alarm 1 inactive, 1 = Alarm 1 active
Alarm 2 Status	Operator/User	<b>1471</b>	5BF	RO	0 = Alarm 2 inactive, 1 = Alarm 2 active

Name	HMI Mode	Dec	Hex	Access	Comments
Digital Input Function	Input	<b>1007</b>	3EF	R/W	The function digital input controls: 0 - No Action 1 – Limit & Alarm Reset (High)
Cold Junction Compensation	Input	<b>1006</b>	3EE	R/W	0 = Cold Junction Disabled, 1 = Enabled
Filter Time	Input	<b>1004</b>	3EC	R/W	0 (OFF) or 5 to 1000 = Input filter time OFF or 0.5 to 100.0 seconds, in 0.5s increments
Scale Range Lower Limit	Input	<b>1002</b>	3EA	R/W	Max working temperature, or display value for the max linear input level.
Scale Range Upper Limit	Input	<b>1001</b>	3E9	R/W	Min working temperature, or display value for the min linear input level.
Decimal Point Position	Input	<b>1003</b>	3EB	R/W	The number of decimal places displayed: 0 - XXXX 1 – XXX.X 2 – XX.XX (linear inputs only) 3 – X.XXX (linear inputs only)
Input Units	Input	<b>1005</b>	3ED	R/W	0 = Deg C, 1 = Deg F

Name	HMI Mode	Dec	Hex	Access	Comments	
Input Type	Input	1000	3E8	R/W	Value	Range
					0	J Thermocouple
					1	K Thermocouple
					2	PT100
					3	B Thermocouple
					4	C Thermocouple
					5	L Thermocouple
					6	N Thermocouple
					7	R Thermocouple
					8	S Thermocouple
					9	T Thermocouple
					10	0 – 20mA
					11	4 – 20mA
					12	0 – 50mA
					13	10 – 50mA
					14	0 – 5V
					15	1 – 5V
					16	0 – 10V
17	2 – 10V					
User High Calibration Offset	User Calibration	1605	645	R/W	The required adjustment +/- Span	
User High Calibration Point	User Calibration	1604	644	R/W	The adjustment point: Input range maximum to input range minimum	
User Low Calibration Offset	User Calibration	1603	643	R/W	The required adjustment +/- Span	
User Low Calibration Point	User Calibration	1602	642	R/W	The adjustment point: Input range maximum to input range minimum	
User Single Point Offset	User Calibration	1601	641	R/W	The required adjustment +/- Span	
Sensor Break Activate Alarm	Alarms	1409	581	R/W	0 = Off, 1 = Detected break <u>always</u> activates both alarms (if configured). If Off, alarms only activate if break condition is also an alarm condition.	
Alarm Inhibit	Alarms	1410	582	R/W	Set to inhibit alarms at power-up. 0 = None, 1 = Alarm 1, 2 = Alarm 2 3 = Both Alarms	
Alarm 2 Hysteresis	Alarms	1407	57F	R/W	Alarm 2 switching hysteresis. Limited by the input span	
Alarm 2 Value	Alarms	1406	57E	R/W	Alarm 2 value. Limited by the input span	
Alarm 2 Type	Alarms	1404	57C	R/W	0 = None (alarm not used) 1 = High Alarm 2 = Low Alarm 3 = Deviation 4 = Annunciator	
Alarm 1 Hysteresis	Alarms	1403	57B	R/W	Alarm 1 switching hysteresis. Limited by the input span	



Name	HMI Mode	Dec	Hex	Access	Comments
Alarm 1 Value	Alarms	<b>1402</b>	57A	R/W	Alarm 1 value. Limited by the input span
Alarm1Type	Outputs	<b>1400</b>	578	R/W	0 = None (alarm not used) 1 = High Alarm 2 = Low Alarm 3 = Deviation 4 = Annunciator
Limit Startup Latch	Outputs	<b>1104</b>	450	R/W	0 = Reset Latch (resets at power on) 1 = Always Latch (latches at power on) 2 = Last Latch (keep last state at power on)
Limit Value	Outputs	<b>1481</b>	5C9	R/W	The 'Exceed' value at which the limit output will trip. Settable within the input range.
Limit Type	Outputs	<b>1480</b>	5C8	R/W	0 = High Limit Action, 1 = Low Limit Action
Linear Type	Outputs	<b>1140</b>	474	R/W	PV Retransmit Possible types. Valid if linear output fitted.  0=0-5V 1=0-10V 2=2-10V 3=0-20mA 4=4-20mA 5=1-5V
Linear Out 3 Scale Maximum	Outputs	<b>1141</b>	475	R/W	PV value where retransmit output is at min level (e.g. 4mA if type is 4-20). Adjustable from -1999 to 9999
Linear Out 3 Scale Minimum	Outputs	<b>1142</b>	476	R/W	PV value where retransmit output is at max level (e.g. 20mA if type is 4-20). Adjustable from -1999 to 9999
Output 3 Indicator Invert	Outputs	<b>1131</b>	46B	R/W	0 = Sync with output, 1 = Opposite to output (e.g. ON when output off)
Alarm 2 StartUp Latch	Outputs	<b>1134</b>	46E	R/W	0 = Reset Latch (resets at power on) 1 = Always Latch (latches at power on) 2 = Last Latch (keep last state at power on)
Output 3 Alarm Latching	Outputs	<b>1133</b>	46D	R/W	0 = Off, 1 = On (will latch on when active)
Output 3 Alarm Action	Outputs	<b>1132</b>	46C	R/W	0 = Direct, 1 = Reverse (off if alarm active)
Output 2 Indicator Invert	Outputs	<b>1121</b>	461	R/W	0 = Sync with output, 1 = Opposite to output (e.g. ON when output off)
Alarm 1 Startup Latch	Outputs	<b>1124</b>	464	R/W	0 = Reset Latch (resets at power on) 1 = Always Latch (latches at power on) 2 = Last Latch (keep last state at power on)

Name	HMI Mode	Dec	Hex	Access	Comments
Output 2 Alarm Latching	Outputs	<b>1123</b>	463	R/W	0 = Off, 1 = On (will latch on when active)
Output 2 Alarm Action	Outputs	<b>1122</b>	462	R/W	0 = Direct, 1 = Reverse (off if alarm active)
Output 1 Indicator Invert	Outputs	<b>1101</b>	44D	R/W	0 = Sync with output, 1 = Opposite to output (e.g. ON when output off)
Limit Output 1 Latching	Outputs	<b>1103</b>	44F	R/W	0 = Off, 1 = On (will latch on when active)
Parity	Communications	<b>1501</b>	5DD	R/W	0 = None, 1 = Even, 2 = Odd
Baud Rate	Communications	<b>1502</b>	5DE	R/W	0 = 1200 bps 1 = 2400 bps 2 = 4800 bps 3 = 9600 bps 4 = 19200 bps 5 = 38400 bps
Modbus Address	Communications	<b>1500</b>	5DC	R/W	Unique instrument network address from 1 to 255
Selected Language	Display	<b>1828</b>	724	R/W	Language selection. 0 = English, 1 = The installed alternative language
Alterative Language	Display	<b>1808</b>	710	RO	The Installed alternative language. 0 = German, 1 = English, 2 = French
Screen Timeout	Display	<b>1830</b>	726	R/W	0 = 5mins, 1 = 15mins & 2 = 30mins without keypress before timeout
Advanced Lock Code	Display	<b>1803</b>	70B	R/W	The password to enter the Advanced Menu 0 = Off, or 1 to 9999
Setup Lock Code	Display	<b>1804</b>	70C	R/W	The password to enter the Setup Menu 0 = Off, or 1 to 9999
DOM	Information	<b>505</b>	1F9	RO	Encoding e.g. 0403 for April 2003 is returned as 193 hex.
<b>Serial Number</b> formed of aaaa bbbb cccc (12 BDC digits):					
Serial Number High	Information	<b>504</b>	1F8	RO	First four digits, aaaa, bits 32-47
Serial Number Mid	Information	<b>503</b>	1F7	RO	Middle four digits, bbbb, bits 16-31
Serial Number Low	Information	<b>502</b>	1F6	RO	Last four digits, cccc, bits 0-15
PRL	Information	<b>506</b>	1FA	RO	Formatted as high byte hardware number as integer [0-99], low byte ascii character [A-Z] for software.
Firmware Type Low	Information	<b>65451</b>	FFAB	RO	(e.g. 227E). Returned as ascii
Firmware Type High	Information	<b>65450</b>	FFAA	RO	(e.g. 227E). Returned as ascii
Firmware Version High	Information	<b>65458</b>	FFB2	RO	(e.g. 10p12). Returned as ascii

Name	HMI Mode	Dec	Hex	Access	Comments
Firmware Version Mid	Information	<b>65457</b>	FFB1	RO	(e.g. 10p12). Returned as ascii
Firmware Version Low Mid	Information	<b>65456</b>	FFB0	RO	(e.g. 10p12). Returned as ascii
Firmware Version Low	Information	<b>65455</b>	FFAF	RO	(e.g. 10p12). Returned as ascii
Communications Option (RS485)	Information	<b>603</b>	25B	RO	0= Not Fitted, 1= Fitted.
Option3	Information	<b>602</b>	25A	RO	0= None, 1= Relay, 5=Linear
Option2	Information	<b>601</b>	259	RO	0= None, 1=Relay, 3=SSR
Option1	Information	<b>600</b>	258	RO	1= Relay as fixed output for Option 1.
Supply Voltage	Information	<b>511</b>	1FF	RO	0= 240V, 1= Low Voltage
Variant	Information	<b>510</b>	1FE	RO	1= Standard, 0= Extrusion, 2= Limit
Digital Input	Information	<b>509</b>	1FD	RO	0= Non-isolated, 1= Isolated.

## Specification for MaxVU Rail



Check your product code for exact hardware fitted.

Process Input	
Thermocouple calibration:	±0.25% of full range, ±1LSD & ±1°C for Thermocouple CJC. BS4937, NBS125 & IEC584.
PT100 calibration:	±0.25% of full range, ±1LSD. BS1904 & DIN43760 (0.00385Ω/Ω/°C).
DC Calibration	±0.25% of full range, ±1LSD.
Sampling Rate:	4 per second.
Impedance:	>1MΩ resistive, except dc mA (5Ω) and V (47kΩ)
Sensor Break Detection:	Thermocouple, RTD, 4 to 20mA, 10 to 50mV, 2 to 10V and 1 to 5V ranges only. Control outputs turn <u>off</u> when a sensor break is detected. Limiter versions go to Exceed condition.
Digital Input (Isolation & Non-isolated version)	
Functions:	Reset Alarm, Control Enable/Disable, Auto/Manual, Pre-Tune Start/Stop or Tune at SP Start/Stop. Fixed function Reset Limit/Alarms only on limiter versions.
Signal:	Non-isolated - Open or Closed contacts only. Isolated - Open (2 to 24Vdc) or Closed (< 0.8Vdc). Closed to Open transition = <b>Reset, Enabled, Auto</b> or <b>Start</b> .
Outputs	
Relays	
Contact Type:	<b>Output 1</b> (Limit on Limiter) – Form C SPDT, 2A @250vac, resistive. <b>Output 2</b> (Alarm 1 on Limiter) & <b>Output 3</b> (Alarm 2 on Limiter) – Form A SPST relay, 2A @ 250Vac, resistive.
Lifetime:	>150,000 operations at rated voltage/current, resistive load.
SSR Driver	
Capacity:	SSR drive voltage >10Vdc at 20mA
Linear Output	
Linear Types:	0 to 20mA, 4 to 20mA, 0 to 5V, 0 to 10V or 2 to 10V
Load Resistance:	Current Output 500Ω max, Voltage Output 500Ω min.
Resolution:	8 bits in 250ms (10 bits in 1s typical, >10 bits in >1s typical).
Serial Communications -RS485 – Modbus RTU	
The rear bus connection and top RS485 connection are not intended for use at the same time.	
Data Rate:	1200, 2400, 4800, 9600, 19200 or 38400 bps.
Parameter Defaults:	Address:1 Baud Rate: <b>9600</b> Parity: <b>None</b> .
Please refer to Modbus Addresses section for more information.	

<b>Operating Conditions</b>	
Usage:	For indoor use only. Din-Rail mounted in a suitable enclosure.
Relative Humidity:	20% to 95% non-condensing.
Operating Temperature:	<95% humidity 0°C to 55°C
Storage Temperature:	<95% humidity -10°C to 80°C
Altitude:	< 2000m
Power Supply:	Mains power version - 100 to 240Vac ±10%, 50/60Hz, 9VA Low voltage version - 24Vac +10/-15% 50/60Hz 9VA or 24Vdc +10/-15% 5W.
<b>Environmental</b>	
Standards:	CE, UL & cUL. FM 3545 applies to the Limiter model only.
EMI:	EN61326-1:2013, Table 2 & Class A.
<b>Warning:</b> This is a Class A product. In a domestic environment, this product may cause radio interference in which case the user may be required to take adequate measures.	
Safety:	UL61010-1 Edition 3 & EN61010 Version 2010, Pollution Degree 2 & Installation Class 2.
Protection Rating:	IP20
<b>Physical</b>	
Unit Size:	Height - 99mm; Width - 22.5mm; Depth - 121mm.
Ventilation:	80mm free space required above and below each unit.
Weight:	0.20kg maximum.

## MaxVU Rail Product Coding

Standard (MVR-x0x-xxxx-xxxx) and Extrusion (MVR-xEx-xxxx-xxxx) models

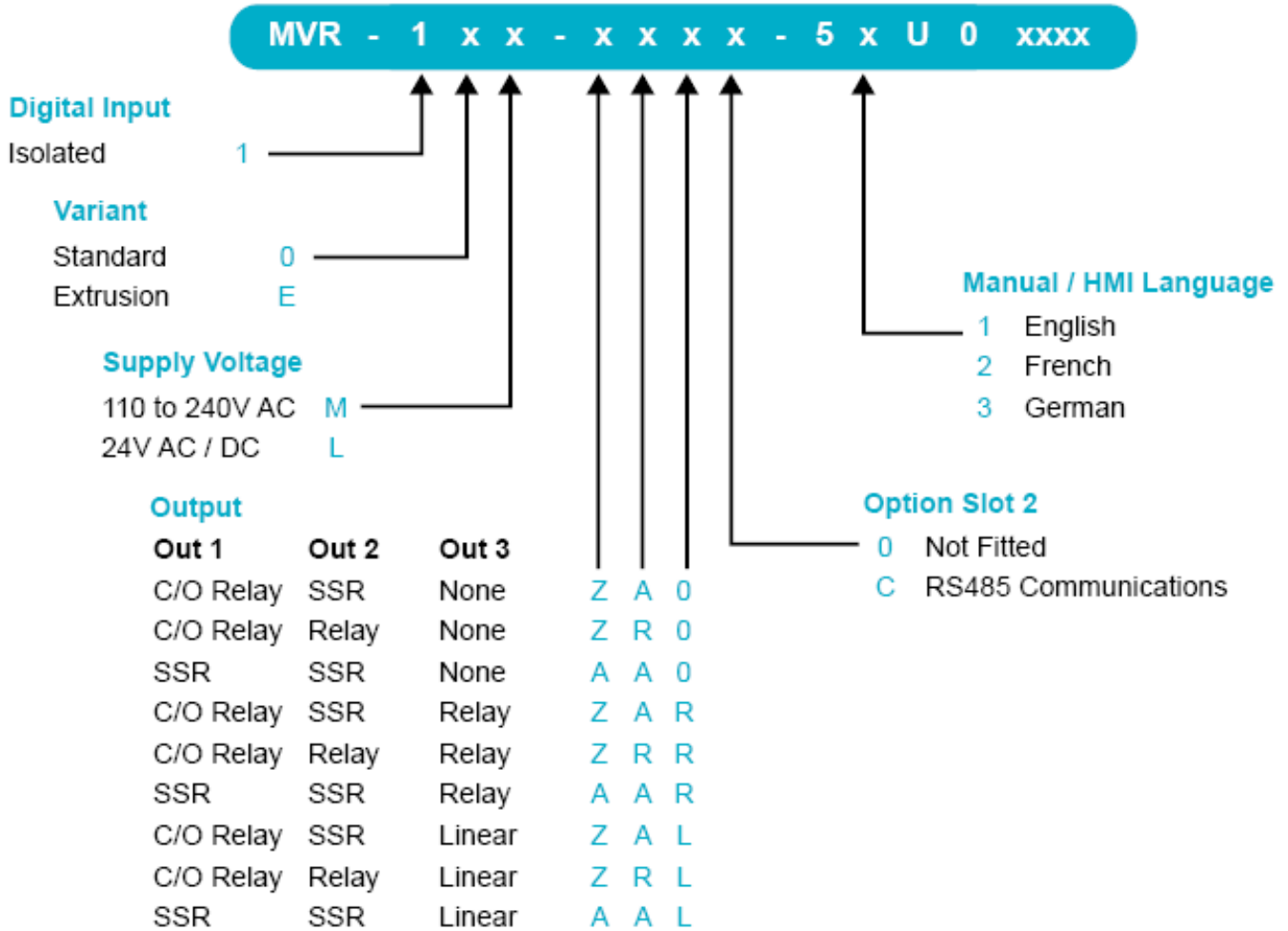

## Limiter model (MVR-xTx-xxxx-xxxx)

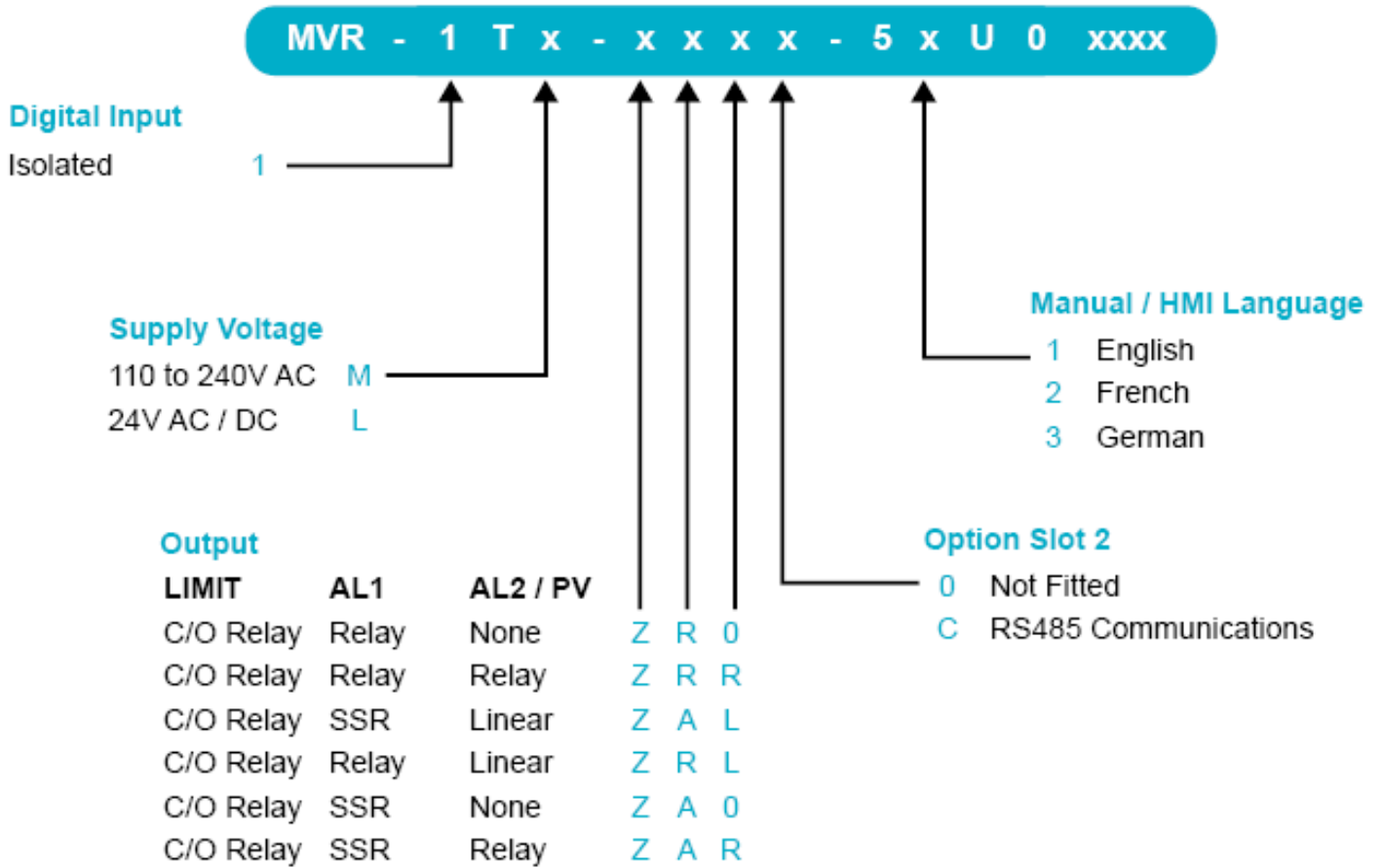

## FAQs

### What happens if my Lock Code has been Changed or I forget my Lock Codes?

If the Lock Codes have been changed, or forgotten, you can use the lock code view screen to read the present settings.

Hold  button whilst powering up for a read-only view of lock codes. Once the codes are noted down power cycle the instrument to start normally. Be patient, it takes approx. 30 seconds to enter this screen from start-up. The lock-codes can be changed in this screen if required.

### What is the difference between PID control & On-Off control?

On-off control operates like a home thermostat –generally “on” below setpoint, and “off” above. PID control tries to set the power level to a value within a “proportional band”, to match that required by the process. E.g. if 65% of power is needed, a 4-20mA output is set to 14.4mA.

#### ON/OFF Control

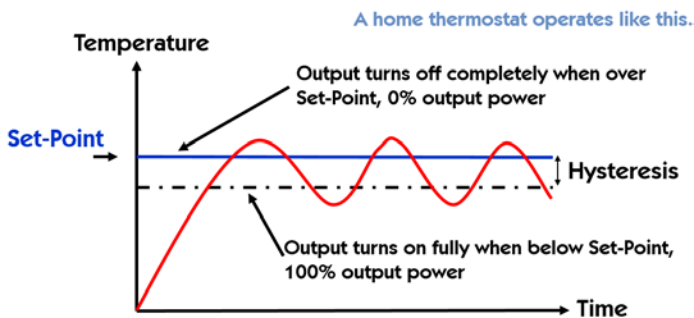

#### Conventional P.I.D. Control

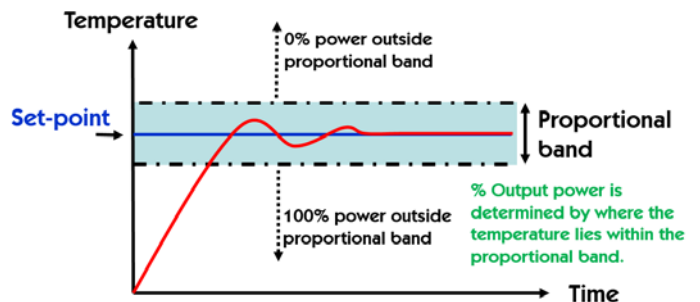

When PID control is used with SSR drive or relay outputs (devices that can on ever be “on” or “off”), the controller can set the power anywhere between 0% and 100%, by switching the output on and off proportionally over the cycle time. E.g. the diagram below highlights where the output on for 6.5 seconds of the 10 second cycle, time giving an average of 65% power at that point.

#### Cycle-time and Proportional Band

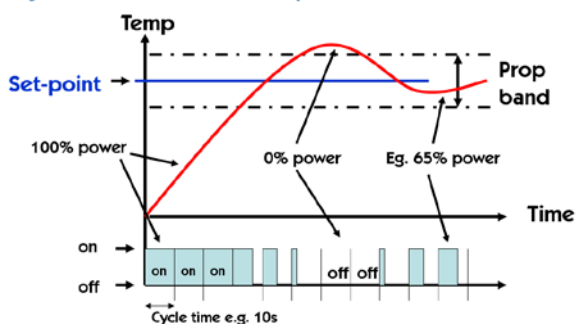

If tuned correctly, PID is more stable than On-Off control, by pulsing on / off proportionally, once every cycle time when inside the Proportional Band, but requires more effort to set up correctly. Generally, with mechanical relays / valves, it is recommended to set **Heat Cycle Time** or **Cool Cycle Time** to >30s switching rate to reduce wear. The automatic tuning features, pre-tune or tune



at setpoint, can be used to more easily optimise the other PID settings.

PID is not needed for some basic applications, and some devices (some gas burners for example), are not suitable to be switched in this way. In these cases, set the **Proportional Heat Band** or **Proportional Cool Band** to zero (off) to enable On-Off control.

### My MaxVU Rail is giving an incorrect reading, what should I do?

Firstly, check you have connected the sensor to the correct terminals for your sensor type.

Next refer to the Input Type table (see Setup menu) to and check that the **Input Type** is set to match the connected sensor. If unsure refer to the Temperature Sensor Identification and Thermocouple & RTD (PT100) section or contact your sensor supplier.

If using a linear dc input, then check the correct type has been selected and that the input scaling matches the signal source. Check the label or manual for this information. For example, the 4 to 20mA output of a %RH sensor may equate to 10% to 90% humidity. This would require the **Input Type** set as 4-20mA, then adjust the **Scale Range Maximum** to 90 and the **Scale Range Minimum** to 10.

Next check the parameters in the **User Calibration** menu. If used it is important that these parameters are set correctly, otherwise the resulting PV reading will be wrong.

Lastly, if you still suspect a problem, check and if necessary adjust the instruments Base Input Calibration.

### What is an Annunciator?

This is a special type of alarm output that is linked to a Limit Controller's main Limit Output. Like the Limit Output, an Annunciator activates when an Exceed condition occurs. It, remains active until a reset instruction is received, or the Exceed condition has passed. Unlike a Limit Output, Annunciators can be reset even if the Exceed condition is present. This is ideal to acknowledge and silence an audible alarm before correcting a problem.

### What is a Limiter / Limit Controller?

It is a protective device to shut down a process at a pre-set Exceed Condition, typically to prevent damage to equipment or products. A 'fail-safe' latching relay is used, which cannot be reset by the operator until the process returned to a safe condition. The reset may be applied from the instrument keypad, digital input or command via serial communication.

Limit controllers work independently to the normal process controller, ideally with their own dedicated signal source.

Limit Controllers can have specific approvals for safety critical applications. These types are recommended for any process that could potentially become hazardous under fault conditions.

### What does Exceed Condition mean?

Limit Controller applications, this is when the process exceeds the Limit Setpoint value. E.g. if the PV is above the Limit SP when set for high limit action, or below the Limit SP for low limit action. The Limit Controller will shut down the process when this condition occurs, and cannot be reset until the Exceed Condition has passed.

### What does 'Latching' mean?

An output that once active, requires a reset signal before it will deactivate. Latching is available on Limit and process alarm outputs. To successfully deactivate (reset) a latched output, the alarm or limit exceed condition that caused it to activate must first be removed. A reset can be given from the instrument keypad, Digital Input or command via serial communication.

### What is a Retransmit Output?

A linear DC Voltage or mA output signal proportional to the Setpoint or Process Variable, for use by slave controllers or external devices, such as recorders or PLCs. The output can be scaled to transmit any portion of the input, but it must be similarly scaled on the receiving device.

## Glossary

### Actual Setpoint

Actual Setpoint is the current effective value of the Setpoint. This will be different to the target value of the setpoint if it is currently ramping. The actual setpoint rises or falls at the ramp-rate set, until it reaches the target Setpoint value.

Refer to [Setpoint](#).

## Alarm Hysteresis

An adjustable band on the "safe" side of an alarm point, through which the process variable must pass before the alarm will change state, as shown in the diagram below.

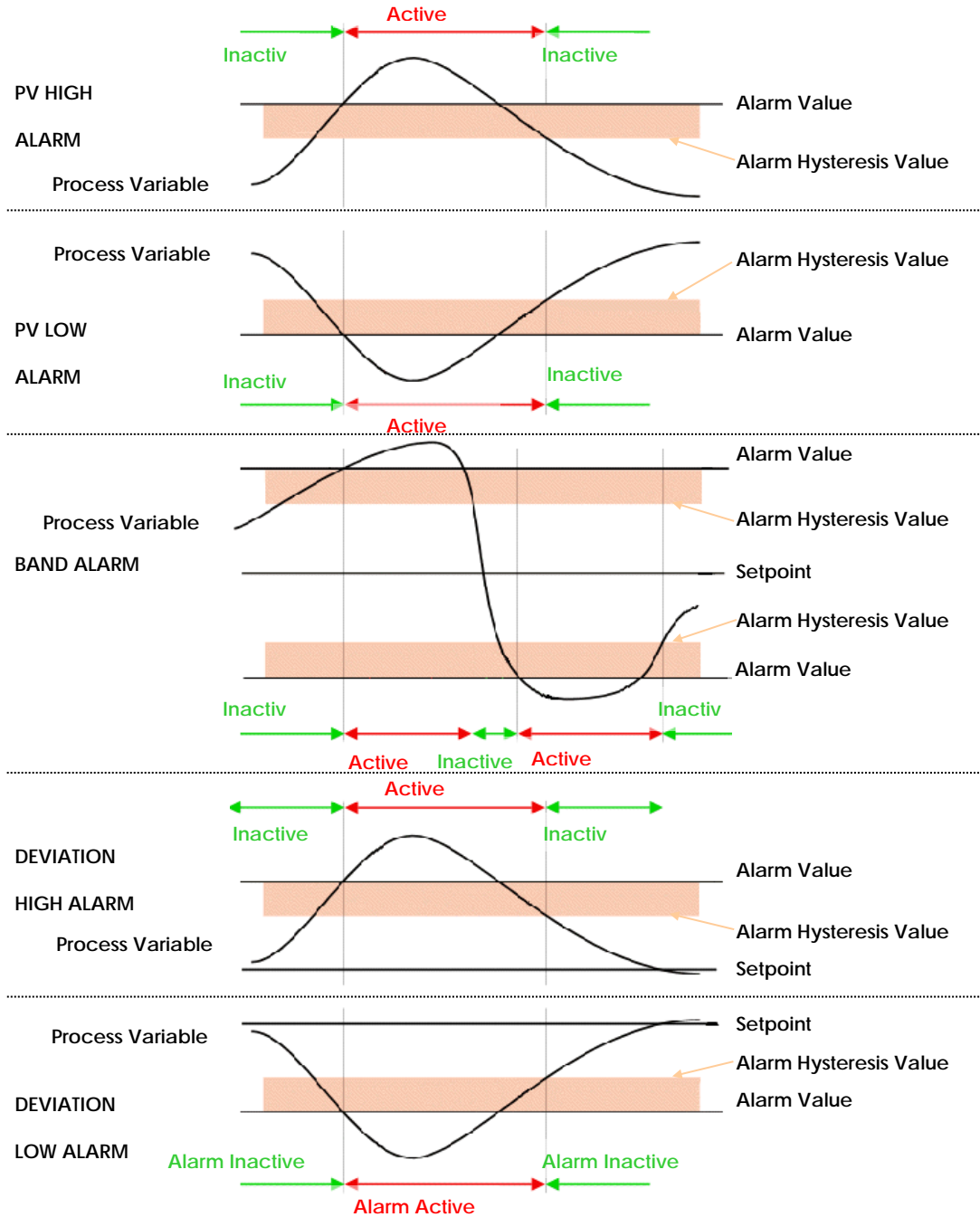

## Alarm Operation

The different alarm types are shown below, together with the action of any outputs.

Also refer to [Alarm Hysteresis](#), [Alarm Inhibit](#), [Latching Relay](#) & [Loop Alarm](#).



## Alarm Inhibit

Inhibits an alarm at power-up or when the controller setpoint is changed, until that alarm would become inactive. The alarm operates normally from that point onwards.

Note that on the Limiter there is a similar function called Start Up Inhibit which is applicable only at power up, not when the limit setpoint is changed.

Also refer to [Alarm Operation](#).

## Automatic Reset (Integral time)

Used to automatically bias proportional control output(s) to compensate for process load variations. It is adjustable in the range 1 seconds to 99 minutes 59 seconds per repeat and OFF. Decreasing the time increases Integral action. This parameter is not available if the primary output is set to On-Off.

Also refer to [Heat Proportional Band](#), [Cool Proportional Band](#), [Rate](#), and [Tuning](#).

## Auto-Tune

Refer to [Pre-Tune](#) and [Tune at Setpoint](#).

## Band Alarm Value

Refer to [Alarm Operation](#).

## Basic Setpoint Control

On MaxVU and MaxVU Rail controllers, when Basic Setpoint Control is enabled the user can only change the set point or the Auto/Man power from the User mode screen. To change other settings the user must enter the Advanced Configuration Mode. The parameter to enable/disable Basic Setpoint Control is in the Display menu.

## Bias (Manual Reset)

Used to manually bias the proportional output(s) to compensate for process load variations. Bias is expressed as a percentage of output power, and is adjustable in the range 0% to 100% (for Heat or Cool outputs alone) or -100% to +100% (for both Heat and Cool Outputs). This parameter is not applicable if the primary output is set to ON-OFF control mode. If the process settles below setpoint use a higher Bias value to remove the error, if the process variable settles above the setpoint use a lower value. Lower Bias values also help to reduce overshoot at process start up.

Also refer to [ON/OFF Control](#).

## Bumpless Transfer

A method to prevent sudden changes to the output power level when switching between automatic and manual control modes. During a transition from automatic to manual, the initial Manual Power value is set equal to the previous automatic mode value. The user then adjusts as required.

During a transition from Manual to Automatic, the initial Automatic Power value is set to equal the previous manual value. The correct power level is gradually applied by the control algorithm at a rate dependant on the integral action (see Automatic Reset). Since integral action is essential to Bumpless Transfer, this feature is not available if Automatic Reset is turned off.

Also refer to [Automatic Reset \(Integral time\)](#) and [Manual Mode](#).

## Calibration - 2 Point (High/Low PV Offset)

Two-point calibration uses two separate points of reference, usually at the process high and low operating limits, to determine the required offsets. These offsets are used to rescale all readings over the full range of the controller minimising inaccuracies in the input reading. See the User Calibration section.

Also refer to [Calibration - Single Point \(PV Offset\)](#) , [Input Span & Span](#) and [Process Variable](#).

## Calibration - Single Point (PV Offset)

Single point calibration uses one point of reference, usually set at a critical process operating value, for the required calibration offset. This offset is applied to all measurements across the input span. See the User Calibration section.

This can be used to compensate for errors in the displayed process variable. Positive values are added to the process variable reading, negative values are subtracted, so MUST be used with care. Incorrect use could cause the displayed value not to show the actual process value.

Also refer to [Calibration - 2 Point \(High/Low PV Offset\)](#), [Input Span & Span](#) and [Process Variable](#).

## Control Type

In the Out 1, Out 2 and Out 3 parameters to set the direction of output increase/decrease vs the movement of the process. Heat is reverse acting, Cool is direct acting (e.g. cooling output increases when the temperature rises).

Refer to [Heat Proportional Band](#), and [Cool Proportional Band](#).

## Controller

An instrument that can control a process, using either PID or On-Off control methods. Alarm outputs are also available, as are other options and Serial Communications.

Refer to [Alarm Operation](#), [Limit Controller](#), [On-Off Control](#), and [Serial Communications](#).

## Cool Proportional Band

The Cool Proportional Band is only applicable when a Cool Output is used. It is the portion of the input span over which the Cool Output power level is proportional to the process variable value. Adjustable in input units' equivalent to 0.5% to 999.9% of span (zero = On-Off control). The Control action for the Cool outputs is direct acting.

Refer to [Control Type](#), [On-Off Control](#), [Heat Proportional Band](#) and [Tuning](#).

## Cycle Time

For time-proportioning outputs, cycle time is used to define the time over which the average ON vs. OFF time is equal to the required PID output level. The range of values is 0.1 to 512 seconds in 0.1s steps. Shorter cycle times will give better control, but at the expense of reduce life when used with an electromechanical control device (e.g. relays or solenoid valves).

Also refer to [Time Proportioning](#).

## Deadband

Refer to [Overlap/Deadband](#).

## Derivative

Refer to [Rate](#).

## Deviation Alarm

Refer to [Alarm Operation](#).

## Heat or Cool Output Power Limits

Used to limit the power level for heating or cooling to protect the process or heaters. Adjustable from 0% to 100%. This parameter is not applicable if the primary output is set for On-Off control.

Also refer to [On-Off Control](#).



## Heat Proportional Band

The Heat Proportional Band is only applicable when a Heat output is used. It is the portion of the input span over which the Heat Output power level is proportional to the process variable value. Adjustable in input units' equivalent to 0.5% to 999.9% of span (zero = On-Off control). The Control action for the Heat outputs is reverse acting.

Also refer to [Control Type](#), [On-Off Control](#), [Cool Proportional Band](#), and [Tuning](#).

## Input Filter Time

Used to filter out extraneous impulses ("noise") on the process input. The filtered PV is used for all PV-dependent functions (display, control, alarm etc). The time constant is adjustable from 0.0 seconds (off) to 100.0 seconds in 0.5 second increments.

Also refer to [Process Variable](#).

## Input Range and Input Span

The [Input Range](#) is the overall non-restricted range as determined by the **Type** parameter in the input menu.

The [Input Span](#) (or Scaled Range) is the limited working range set by the upper and lower limits in the input menu. The input span is used as the basis for calculations that relate to the span of the instrument (e.g. controller proportional bands).

Also refer to [Scale Range Lower](#) and [Scale Range Upper](#).

## Limit Controller or Limiter

A protective device that can shut down a process at a pre-set Exceed Condition, to prevent possible damage to equipment or products. They are recommended for any process where product or equipment damage might occur, or if it could become hazardous under fault conditions.

## Loop Alarm

This is a special alarm, to detect problems with the control feedback loop. It continuously monitors the process response to the control output.

If control is at the maximum or minimum limit (0% or 100% for single Heat or Cool output and -100% & +100% for dual [Heat and Cool](#) outputs), an internal timer starts. If the process variable is not moved in the expected direction by a predetermined amount 'V' after time 'T' has elapsed, the loop alarm becomes active.

Only when the process has moved by "V", or when the output is no longer at the limit, does the loop alarm deactivate.

\*If the heat or cool power limits are less than 100% the limited value is used as the maximum. E.g. if the limit is 70%, the timer begins at 70%.

For PID control, the loop alarm time 'T' is always twice the Automatic Reset (Integral) parameter value. For On-Off control, a user defined value for the Loop Alarm Time parameter is used.

The value of 'V' is dependent upon input type. For temperature inputs,  $V = 2^{\circ}\text{C}$  or  $3^{\circ}\text{F}$ . For linear inputs,  $V = 10$  least significant display units.

Correct operation of the loop alarm depends upon reasonably accurate PID tuning. The loop alarm is automatically disabled during manual control mode and during automatic tuning.

Also refer to [Manual Mode](#), [On-Off Control](#), and [Process Variable](#).

## Manual Mode

If manual mode is selected from operator mode (if enabled), via the digital input or serial comms, the PID algorithm is suspended. It must therefore be used with care, because the controller is no longer in control of the process. The operator must maintain the process at the required value, by adjusting the % power output value.

In Manual mode, the display shows the current process value as normal, but the setpoint is replaced with the % output power. This value may be adjusted using keypad, between 0% to 100% for controllers using Heat control only, and -100% to +100% for controllers using dual Heat and Cool control.

Switching between automatic and manual modes is achieved using bumpless transfer.

Note: Manual power is not limited by the power output limits.

Also refer to [Bumpless Transfer](#), and [Heat/Cool Output Power Limit](#).

## Master & Slave

The terms master & slave are used to describe the controllers in applications where one instrument controls the setpoint of another. The master controller (e.g. a profile controller) transmits a setpoint to MaxVU slaves using RS485 serial communications (analogue signals cannot be used because MaxVU does not have a remote setpoint input option). MaxVU cannot act as a Master.

Also refer to [Serial Communications](#) and [Setpoint](#)

## On-Off Control

On-Off control mode, the output(s) turn on or off as the process variable crosses the setpoint just like a home heating thermostat. Some oscillation of the process variable is inevitable with On-Off control.

On-Off control is enabled by setting the corresponding proportional band(s) to Off (zero). It can be assigned to the Heat output alone (Cool output not present), Heat and Cool outputs or Cool output only (with the Heat Output set for time proportional).

Also refer to [Heat Proportional Band](#), [Cool Proportional Band](#), [On-Off Differential](#), [Setpoint](#) and [Time Proportioning Control](#).

## On-Off Differential (Hysteresis)

A switching differential, centred about the Setpoint, when one or both control outputs have been set to On-Off. It is adjustable from 0.1% to 10.0% of input span, entered in display units.

Relay chatter can be eliminated by proper adjustment of this parameter, but larger values do increase amplitude of process oscillations.

Also refer to Input Range and Input Span and [On-Off Control](#).

## PID Control

Proportional Integral and Derivative control maintains accurate and stable levels in a process (e.g. temperature control). It avoids the oscillation characteristic of On-Off control by continuously adjusting the output to keep the process variable stable at the desired Setpoint.

Also refer to [Automatic Reset](#), [Controller](#), [Manual Mode](#), [On-Off Control](#), [PI Control](#), [Heat Proportional Band](#), [Process Variable](#), [Rate](#), [Cool Proportional Band](#), [Setpoint](#) and [Tuning](#)

## Overlap/Deadband

Defines the portion of the Heat and Cool proportional bands over which both outputs are active (Overlap), or neither is active (Deadband). It is set in display units, within a range of -20% to +20% of the sum of the two proportional bands (e.g. If Heat PB is 3 and Cool PB is 2, their sum is 5, and  $\pm 20\%$  is -1 to +1). Positive + values = Overlap, Negative - values = Deadband.

If the Cool Output is set for On-Off, this parameter moves the Differential band of the Cool Output to create the overlap or deadband. When Overlap/Deadband = 0, the "OFF" edge of the Cool Output Differential band coincides with the point at which the Heat Output = 0%.

Also refer to [Differential](#), [On-Off Control](#), [Heat Proportional Band](#) and [Cool Proportional Band](#).

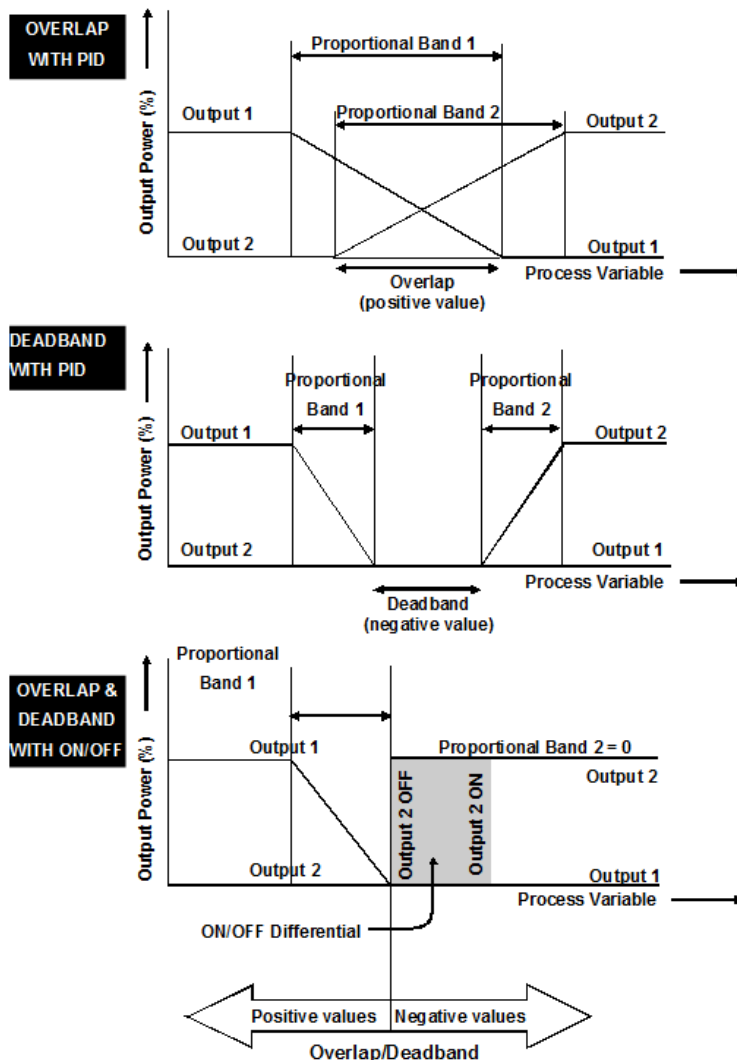

## Pre-Tune

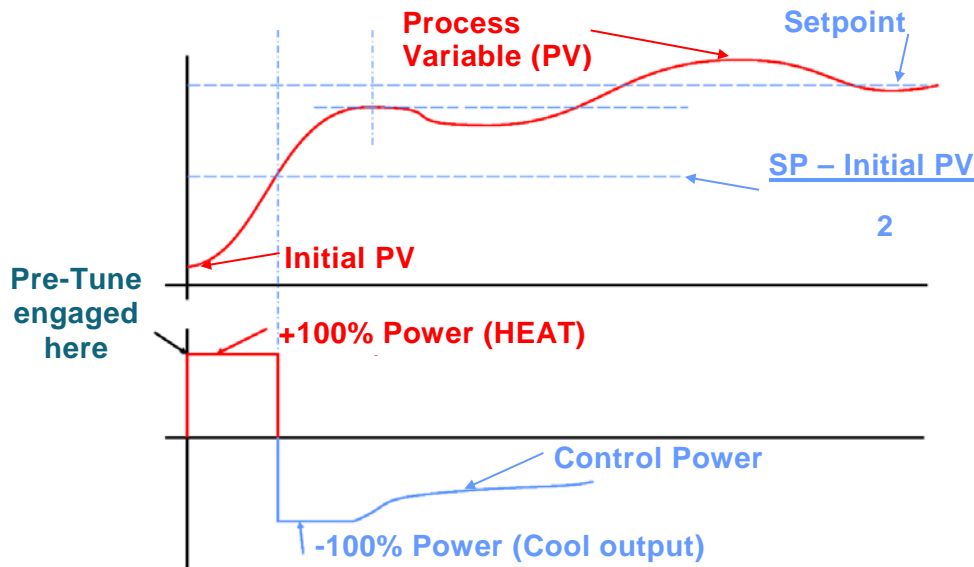

Starting with the load cool\*, Pre-Tune disturbs the process start-up pattern, so that the PID values are calculated before the setpoint is reached.

During Pre-Tune, the controller outputs full Heat Power until the process value has moved approximately halfway to the Setpoint. At that point, power is removed (or full Cool Power with dual control), thereby introducing a process oscillation. Once the oscillation peak has passed, the instrument calculates the PID tuning terms: proportional band(s), automatic reset and rate. Normal PID control operation begins using these calculated values, and Pre-Tune automatically disengages.

\*Ideally the Tune program should be used when the load temperature is close to ambient. Care should be taken to ensure that any overshoot is safe for the process and if necessary tune at a lower setpoint.

Pre-Tune will not engage if either Heat or Cool outputs on a controller are set for On-Off control, the controller is set to Manual, during Setpoint ramping, or if the process variable is less than 5% of the input span from the Setpoint. Refer to the Automatic Tuning section for further details.

Also refer to [Automatic Reset](#), [On-Off Control](#), [Input Span](#), [PID](#), [Heat Proportional Band](#), [Process Variable](#), [Rate](#), [Cool Proportional Band](#), [Setpoint](#), [Setpoint Ramping](#) and [Tuning](#).

## PV High Alarm Value

Refer to [Alarm Operation](#).

## PV Low Alarm Value

Refer to [Alarm Operation](#).

## Process Variable (PV)

Process Variable is the signal measured by the primary input. The PV can be anything that can be converted into a compatible electronic signal. Common types are Thermocouple or PT100 temperature probes, %RH or pressure etc. from transducers that convert them to linear dc signals (e.g. 4 to 20mA). These signals are scaled into engineering units using the [Scale Range Lower Limit](#) and [Scale Range Upper Limit](#) parameters.

Also refer to [Input Range & Span](#), [Scale Range Lower Limit](#) and [Scale Range Upper Limit](#).

## Rate (Derivative)

Rate is adjustable from 0 (OFF) to 99 minutes 59 seconds. It defines how the control output responds to the rate of change in the process. Rate is not available in On-Off.

Also refer to [On-Off Control](#), [PID](#), [Process Variable](#) and [Tuning](#).

## Reset / Integral

Refer to [Automatic Reset](#).

## Reverse Acting

Refer to [Direct/Reverse Action of Control Output](#)

## Scale Range Maximum

For linear inputs, this parameter is used to scale the process variable into engineering units. It defines the displayed value when the process variable input is at its maximum value. It is adjustable from -1999 to 9999 and can be set to a value less than (but not within 100 units of) the Scale Range Lower Limit, in which case the sense of the input is reversed.

For thermocouple and RTD inputs, this parameter is used to reduce the effective range of the input. All span related functions work from the trimmed input span. The parameter can be adjusted within the limits of the Input Range selected. It is adjustable to within 100 degrees of the Scale Range Lower Limit.

Also refer to [Input Range & Span](#), [Process Variable](#) and [Scale Range Lower Limit](#).

## Scale Range Minimum

For linear inputs, this parameter can be used to display the process variable in engineering units. It defines the displayed value when the process variable input is at its minimum value. It is adjustable from -1999 to 9999 and can be set to a value more than (but not within 100 units of) the Scale Range Upper Limit, in which case the sense of the input is reversed.

For thermocouple and RTD inputs, this parameter is used to reduce the effective range of the input. All span related functions, work from the trimmed span. The parameter can be adjusted within the limits of the Input Range selected. It is adjustable to within 100 degrees of the Scale Range Upper Limit.

Also refer to [Input Range & Span](#), [Process Variable](#) and [Scale Range Upper Limit](#).

## Serial Communications Option

A feature that allows devices such as PC's, PLC's or a master controller to read or change an instrument's parameters via a communications link. MaxVU & MaxVU Rail optionally support RS485 Modbus RTU communications as a factory fitted option, in addition to the front configuration port.

Also refer to [Controller](#), [Indicator](#), [Master & Slave](#) and [Limit Controller](#).

## Setpoint

The target value at which a controller will attempt to maintain the process by adjusting its power output level. Setpoints can be adjusted between the Setpoint Upper Limit and Setpoint Lower Limits.

Also refer to [Limit Setpoint](#), [Process Variable](#), and [Setpoint Upper & Lower Limits](#)

## Setpoint Upper Limit and Setpoint Lower Limit

The maximum and minimum values allowed for setpoint adjustments. Set as required to prevent the process going too high or low. Setting both limits to the same value locks the setpoint at that value.

The adjustment range for Setpoint Upper Limit is between current Setpoint and Scale Range Maximum. The value cannot be moved below the current value of the Setpoint.

The adjustment range is between Scale Range Lower Limit and current Setpoint. The value cannot be moved above the current value of the Setpoint.

Also refer to [Scale Range Lower Limit](#), [Scale Range Upper Limit](#) and [Setpoint](#)

## Ramp Rate

The rate at which the actual effective setpoint value moves towards its target value, when the Setpoint is adjusted. With ramping in use, the initial value of the actual Setpoint at power up, enabling control or when switching back to automatic mode from manual control, is equal to the current process variable value. The Actual Setpoint will rise/fall at the ramp rate set, until it reaches the target Setpoint value.

Setpoint ramping is used to protect the process from sudden changes in the Setpoint, which would result in a rapid rise in the process variable. If the setpoint is changed controller attempts to follow at the predefined ramp rate until the new setpoint is reach.

Also refer to [Actual Setpoint](#), [Manual Mode](#) and [Setpoint](#).

## Solid State Relay (SSR)

An external device manufactured using Silicone Controlled Rectifiers, which can be used to replace mechanical relays in most AC power applications. As a solid-state device, an SSR does not suffer from contact degradation when switching electrical current. Much faster switching cycle times are also possible, leading to superior control. MaxVU Rails optional SSR Driver outputs give time-proportioned 10Vdc pulses, which causes conduction of current to the load when the pulse is on.

Also refer to [Cycle Time](#) and [Time Proportioning Control](#).

## Solenoid Valve

An electro-mechanical device to control gas or liquid flow. It has two states, open or closed. Typically, a spring holds the valve closed until current passes through the solenoid coil, forcing it open. Standard Process Controllers with Time Proportioned outputs are used to control solenoid valves.

Solenoid valves are often used with high/low flame gas burners. A bypass supplies some gas at all times, but not enough to heat the process more than a nominal amount (low flame). The controller output opens the valve when the process requires additional heat (high flame).



## Time Proportioning Control

This type of control can be used with electrical contactors, Solid State Relays or valves whenever Relay or SSR Driver outputs are used for either primary (Heat) or secondary (Cool) control. Time-proportioning control is accomplished by cycling the output on and off during the prescribed cycle time, whenever the process variable is within the proportional band. The control algorithm determines the ratio of time (on vs. off) to achieve the level of output power required to correct any error between the process value and Setpoint. E.g. for a 32 second cycle time, 25% power demand would result in the output turning on for 8s, then off for 24s.

Also refer to [Cycle Time](#), [PID](#), [Heat Proportional Band](#), [Process Variable](#), [Cool Proportional Band](#), [Setpoint](#) and [SSR](#).

## Tuning PID

PID Controllers must be tuned to the process for them to maintain optimum control. Adjustment is made to the tuning terms either manually, or by using the controller's automatic tuning facilities. Tuning is not required if the controller is configured for On-Off Control.

Also refer to [Automatic Reset](#), [Cool Proportional Band](#), [Heat Proportional Band](#), [ON-OFF control](#), [PID](#), [Pre-Tune](#), [Rate](#) and [Tune at Setpoint](#).

## Tune at Setpoint

This automatic tuning method can be used if Pre-Tune cannot to run, because the current process temperature is too close to the target setpoint.

Tune at SP is activated via the Setup or Advanced Configuration menus. It can also be activated via the Digital Input or a Modbus command. It works by waiting for the process to “line-out” (approximately stable), then adds a pulse to the control output to cause a small process disturbance. This disturbance is analysed to establish the correct PID tuning terms for the application – see below.

The message ‘TUNE’ is displayed whilst Tune at SP is running. The ‘TUNE’ notification ends when the tuning is complete.

Tune at Setpoint will not engage, and a Tune Error message will be displayed if:

1). There is a sensor break, 2). A setpoint ramp has been set, 3). A Timer is running, 4). Control is Disabled. 5). The current control mode is On-OFF 6). The controller is in Manual mode.

If you have defined outputs for heating and cooling, Tune at SP is not offered in the tuning menu. Instead use Pre-Tune.

## Running Tune at Setpoint from Automatic Control.

It is important to set Scale Range Maximum and Scale Range Minimum correctly before tuning, Also, because Tune at SP needs a reasonable level of process stability to run, it is recommended to set the initial PID values in the Control menu back to their default values. See the Automatic Tuning section for further information.

1. Activate Tune at SP.
2. When Tune at SP begins, the controller carries out a “steady state estimation”. It waits until the process has achieved reasonable stability ( $\pm 1\%$  of span & max control power variation  $\pm 10\%$ ) for 5 minutes.
3. After 5 minutes of stability (see  $T_0$  below) the Pulse response evaluation is carried out. A “power pulse” is applied that reduces the current control power by -20% (except if the current power is already 20% or less, when a positive +20% power pulse is applied instead).
4. The power pulse is maintained until the process responds by 1% of span (see  $T_1$  below). E.g. falling by 1% if the power pulse was negative, or rising if the pulse was positive.
5. The 20% pulse is removed, returning the power to the value just before  $T_0$ .  
The process will continue to its maximum deflection, and returns towards the original value.

6. The controller notes the time taken to recover 0.15% of span, then waits for the recovery to reach 0.3% (see  $T_2$  and  $T_3$  below) before using the pulse response deflection and the time  $T_3 - T_2$  to calculate new PID terms.

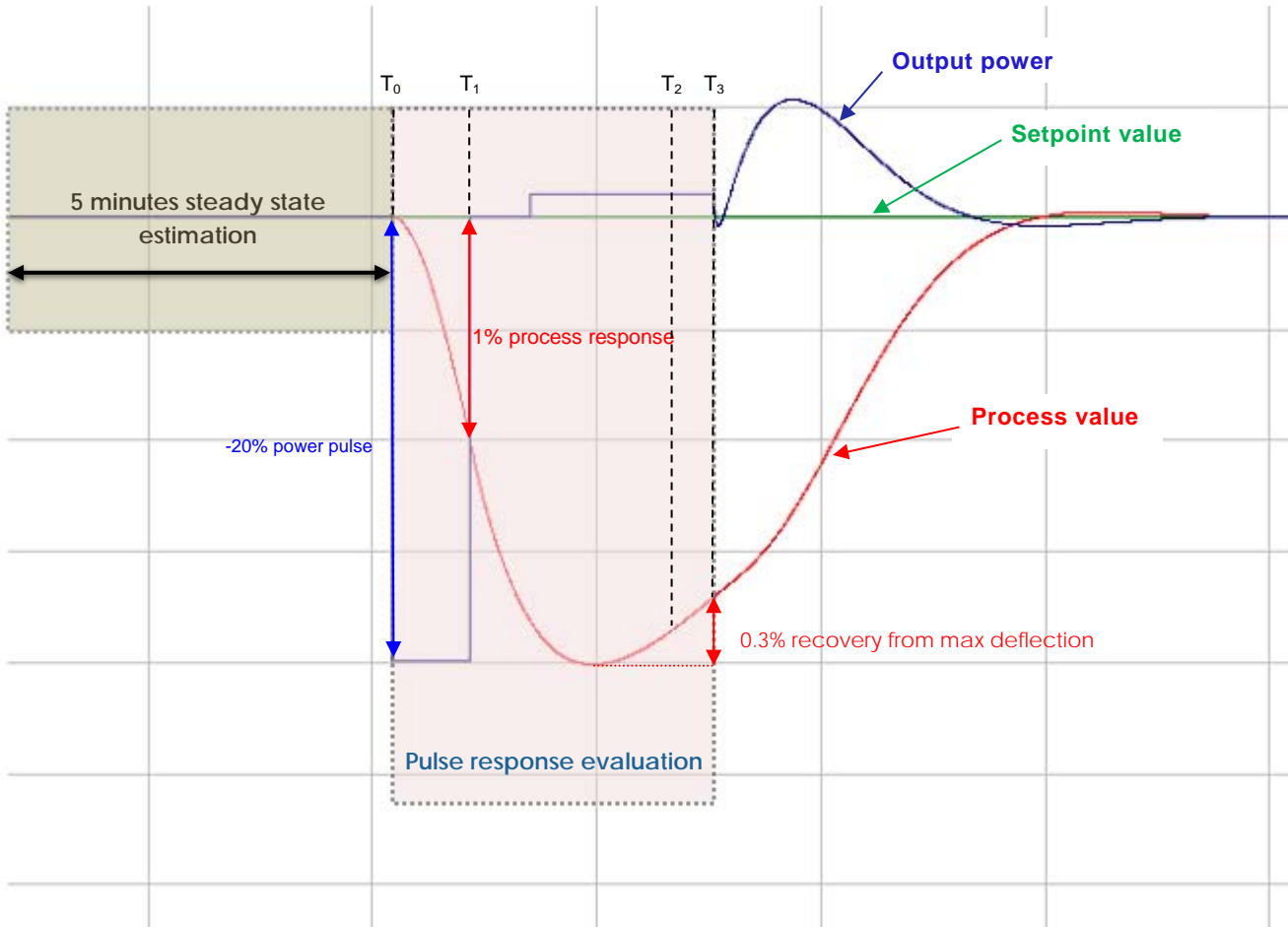

Note: The time tuning takes to complete will vary from process to process.

Also refer to [Automatic Reset](#), [Cool Proportional Band](#), [Heat Proportional Band](#), [ON-OFF control](#), [PID](#), [Pre-Tune](#), [Rate](#) and [Tuning](#).

Contact Details

<p> <b>Austria</b></p> <p>Tel.: +43 (0)2236 691-121 Fax: +43 (0)2236 691-102</p> <p><a href="mailto:AT@West-cs.com">AT@West-cs.com</a> <a href="http://www.west-cs.de">www.west-cs.de</a></p>	<p> <b>China</b></p> <p>Tel: +86 22 2390 0700 Sales: +86 400 666 1802 Fax: +86 22 2390 0710</p> <p><a href="mailto:CN@West-cs.com">CN@West-cs.com</a> <a href="http://www.west-cs.cn">www.west-cs.cn</a></p>	<p> <b>France</b></p> <p>Sales: +33 1 71 84 17 32 Technical: +33 1 71 84 17 31 Fax: +33 1 82 88 27 55</p> <p><a href="mailto:FR@west-cs.com">FR@west-cs.com</a> <a href="http://www.west-cs.fr">www.west-cs.fr</a></p>
<p> <b>Germany</b></p> <p>Tel.: +49 (0)561 505-1307 Fax: +49 (0)561 505-1710</p> <p><a href="mailto:DE@West-cs.com">DE@West-cs.com</a> <a href="http://www.west-cs.de">www.west-cs.de</a></p>	<p> <b>United Kingdom</b></p> <p>Tel.: +44 (0)1273 606271 Fax: +44 (0)1273 609990</p> <p><a href="mailto:UK@West-cs.com">UK@West-cs.com</a> <a href="http://www.west-cs.co.uk">www.west-cs.co.uk</a></p>	<p> <b>United States</b></p> <p>Tel.: 800 866 6659 Fax: 847 782 5223</p> <p><a href="mailto:NA@West-cs.com">NA@West-cs.com</a> <a href="http://www.west-cs.com">www.west-cs.com</a></p>